

FLE04-06

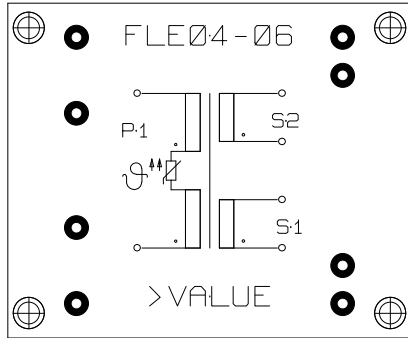

OB115/6M

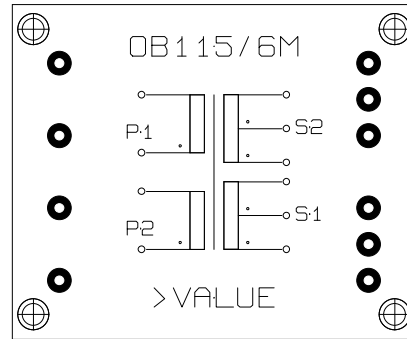

OB115/6

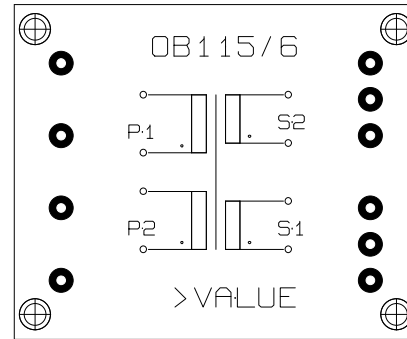

FL02-08

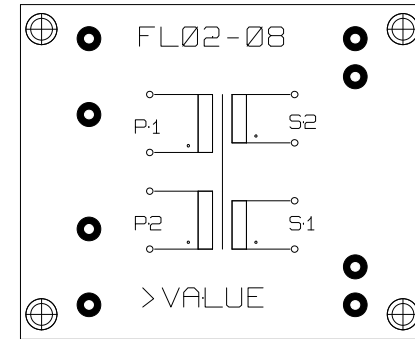

VR07,5-1

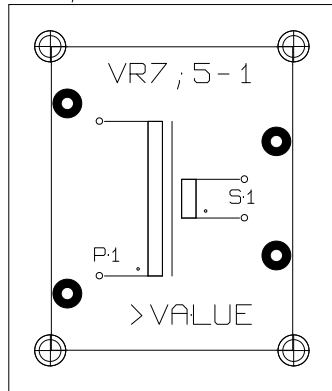

VR07,5-2

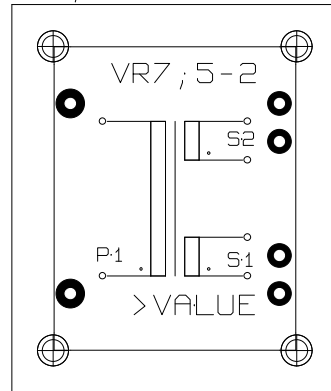

PT07,5-2

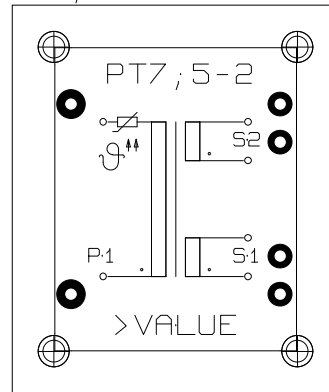

PT07,5-1

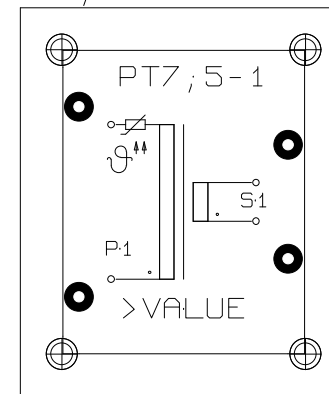

EI48-2

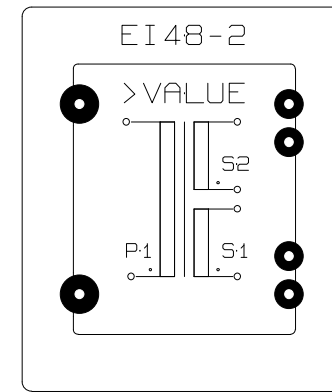

EI48-1

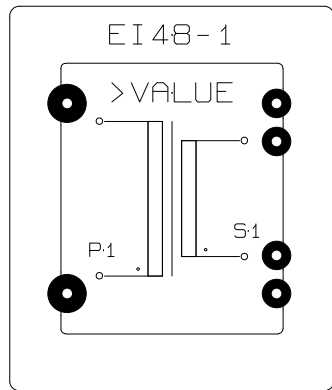

EP07,5

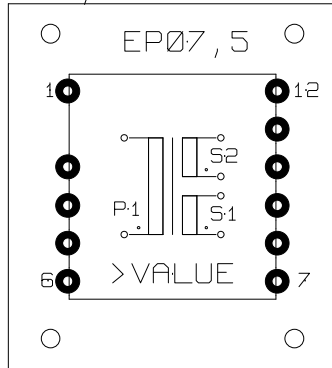

EP07,5B

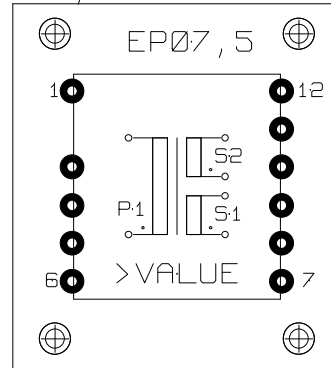

EI30-2VALUE

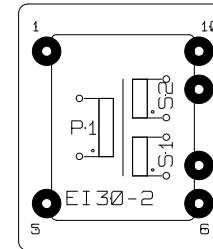

VR11

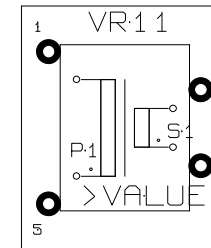

VR12

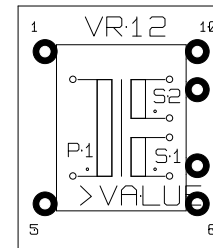

Gerado por Mod2mod.exe v 0.81 beta-teste
 Bibliotecas originais em library.oshec.org
 C:\kicad\convertidos\placas\trafo_6.brd

Renie S. Marquet

Title: Teste Mod2mod gerando guia de footprints

Size: A4 Date: 19 aug 2007

Rev: 0.1

KiCad E.D.A. PCBNEW (2007-11-19)

Sheet: 1/1