

FPM-19

EURO

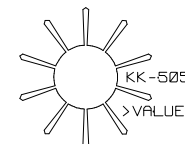
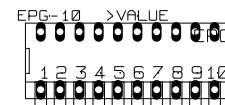
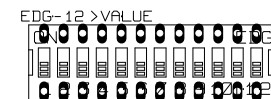
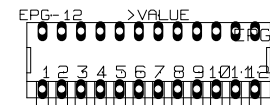
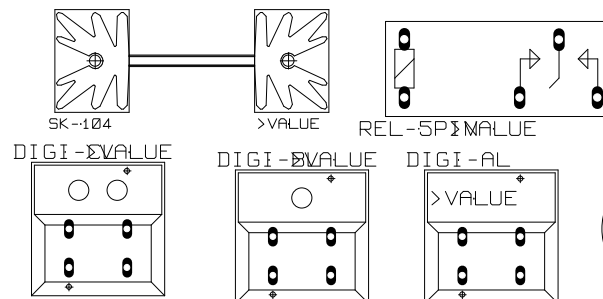
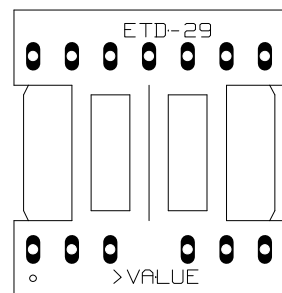
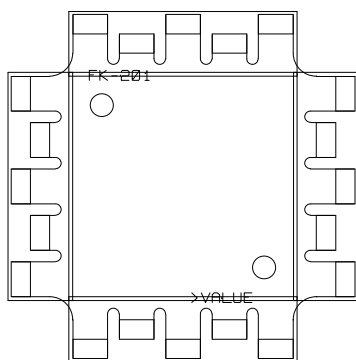
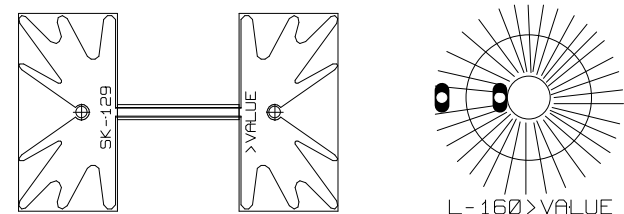
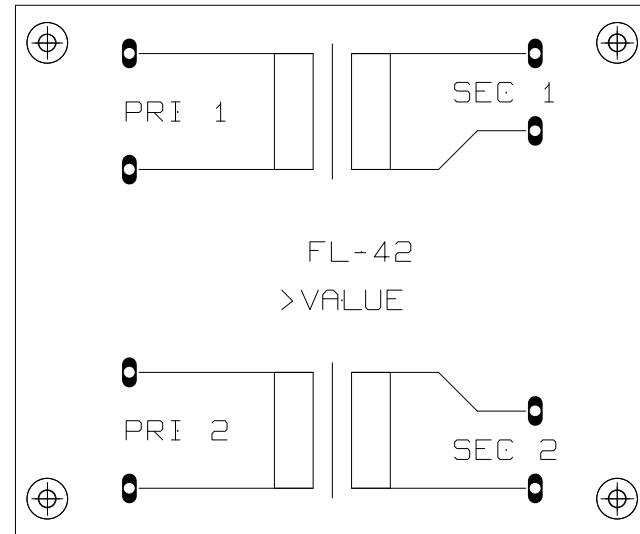

>VALUE

>VALUE

>VALUE

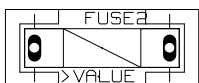
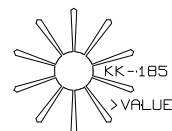
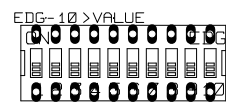
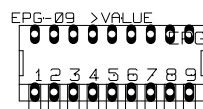

Gerado por Mod2mod.exe v 0.81 beta-teste
 Bibliotecas originais em library.oshec.org
 C:\kicad\convertidos\placas\special_2.brd

Renie S. Marquet		
Title: Teste Mod2mod gerando guia de footprints		
Size: A4	Date: 8 dec 2007	Rev: 0.1
KiCad E.D.A. PCBNEW (2007-11-19)		Sheet: 1/1