

Gerado por Mod2mod.exe v 0.81 beta-teste
 Bibliotecas originais em library.oshec.org
 D:\kicad\convertidos\placas\pga_2.brd

Renie S. Marquet

Title: Teste Mod2mod gerando guia de footprints

Size: A4 Date: 14 aug 2007

Rev: 0.1

KiCad E.D.A. PCBNEW (2007-11-19)

Sheet: 1/1

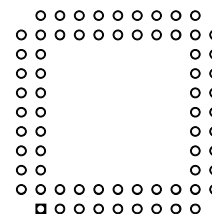
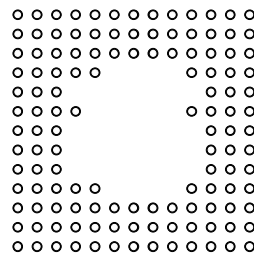
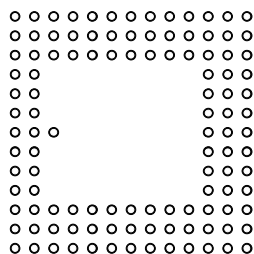
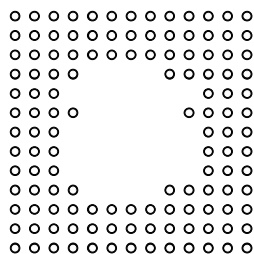
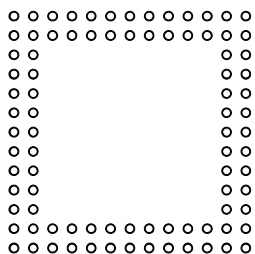
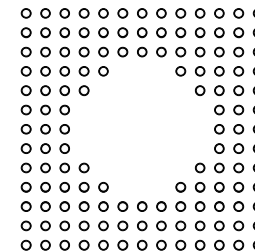
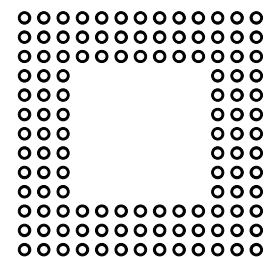
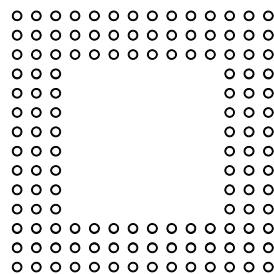
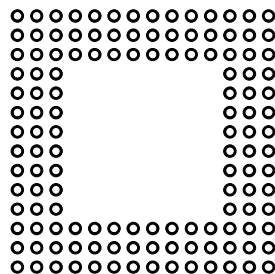
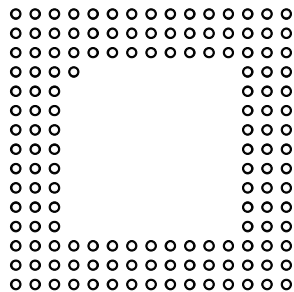
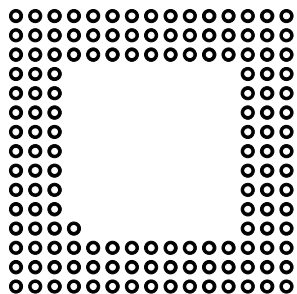
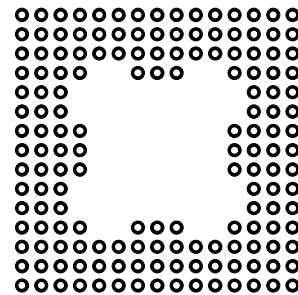
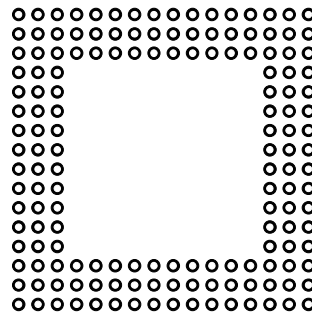
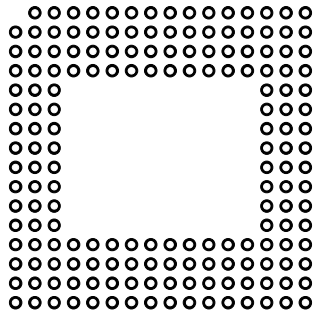
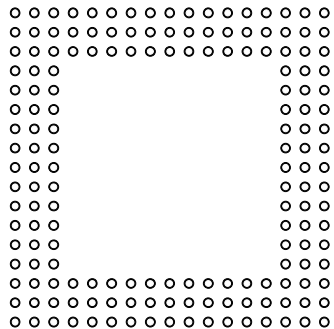
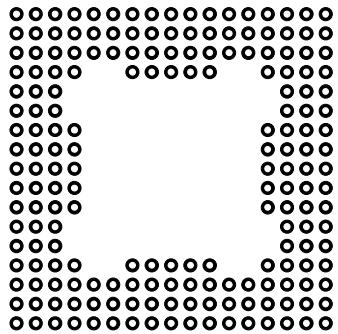

Gerado por Mod2mod.exe v 0.81 beta-teste
 Bibliotecas originais em library.oshec.org
 D:\kicad\convertidos\placas\pga_2.brd

Renie S. Marquet

Title: Teste Mod2mod gerando guia de footprints

Size: A4 Date: 14 aug 2007

Rev: 0.1

KiCad E.D.A. PCBNEW (2007-11-19)

Sheet: 1/1



Gerado por Mod2mod.exe v 0.81 beta-teste
Bibliotecas originais em library.oshec.org
D:\kicad\convertidos\placas\pga_2.brd

Renie S. Marquet

Title: Teste Mod2mod gerando guia de footprints

Size: A4 Date: 14 aug 2007

Rev: 0.1

KiCad E.D.A. PCBNEW (2007-11-19)

Sheet: 1/1

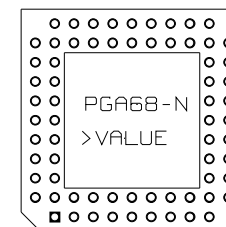
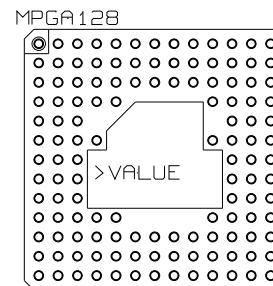
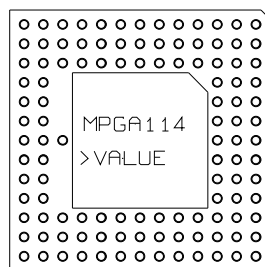
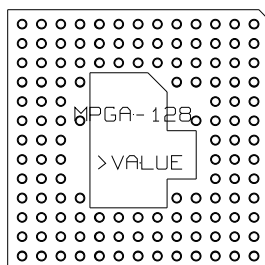
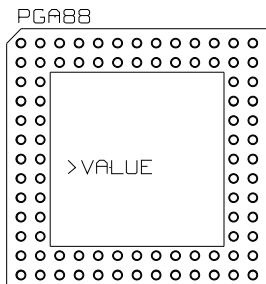
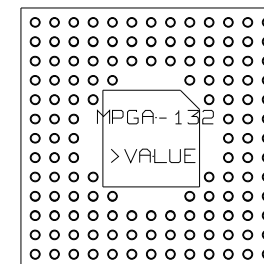
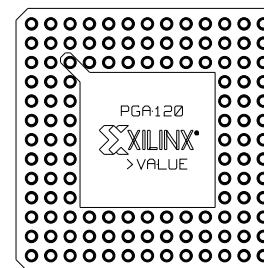
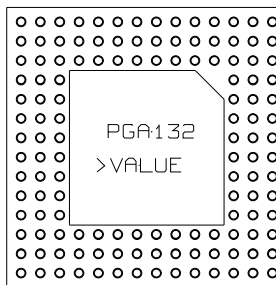
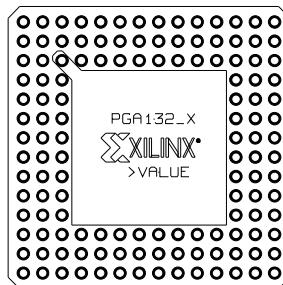
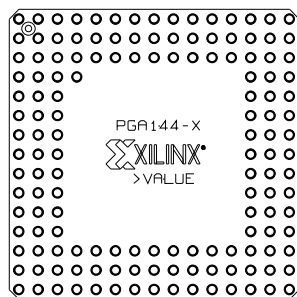
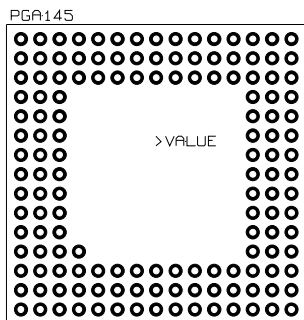
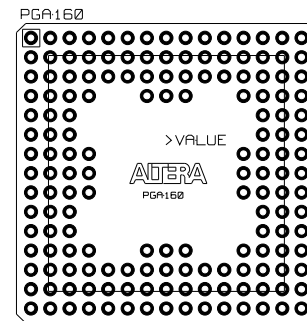
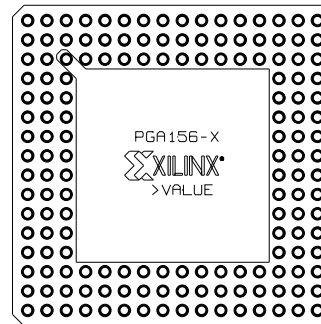
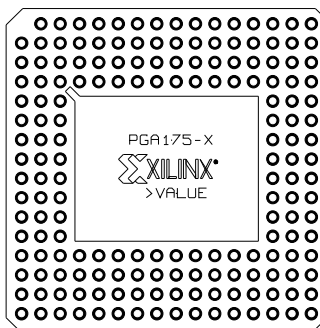
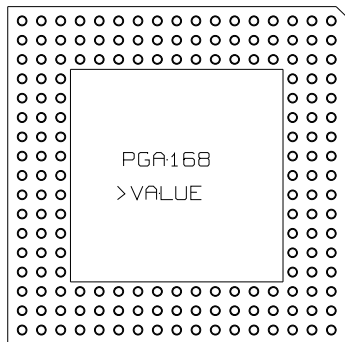
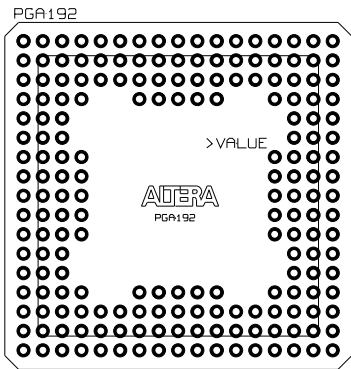

Gerado por Mod2mod.exe v 0.81 beta-teste
 Bibliotecas originais em library.oshec.org
 D:\kicad\convertidos\placas\pga_2.brd

Renie S. Marquet

Title: Teste Mod2mod gerando guia de footprints

Size: A4 Date: 14 aug 2007

Rev: 0.1

KiCad E.D.A. PCBNEW (2007-11-19)

Sheet: 1/1