

Big_ANTENNA-DIPOL

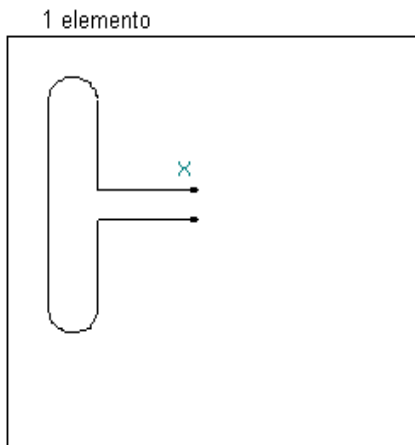

Big_ANTENNA-II

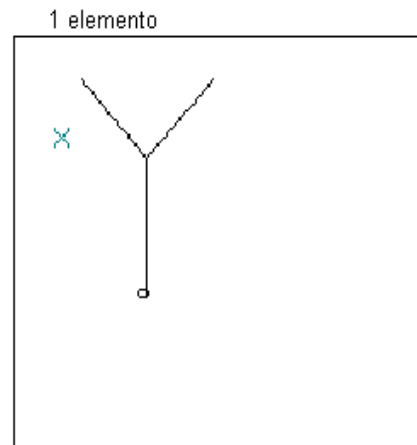

Big_ANTENNA-FRAME

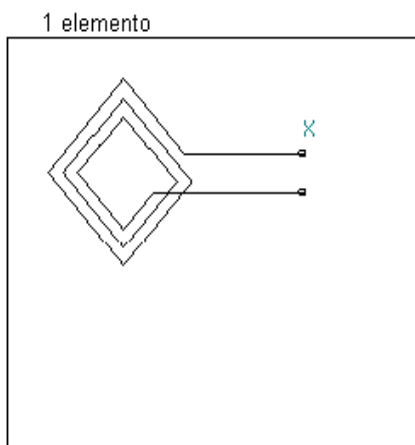

Big_BATTERY

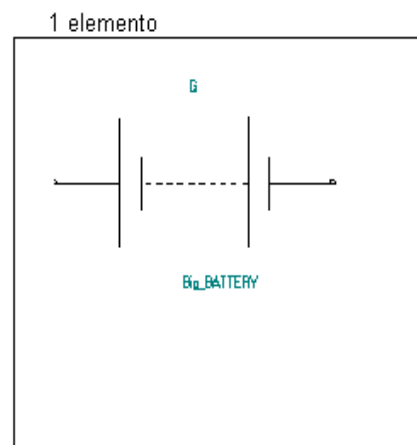

Big_ANTENNA-I

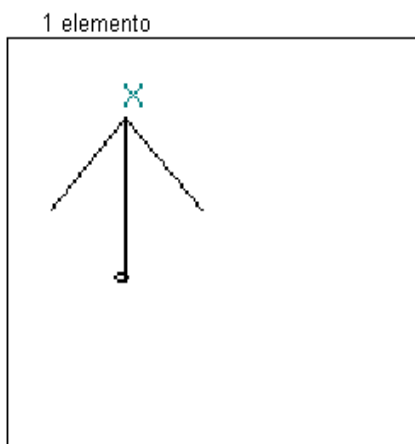

Big_BATTERY-1FI FMFNT

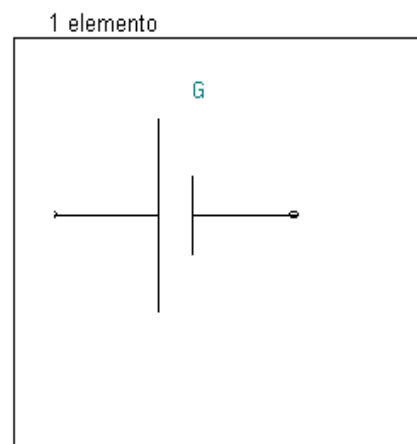

Big_CAPACITOR

1 elemento

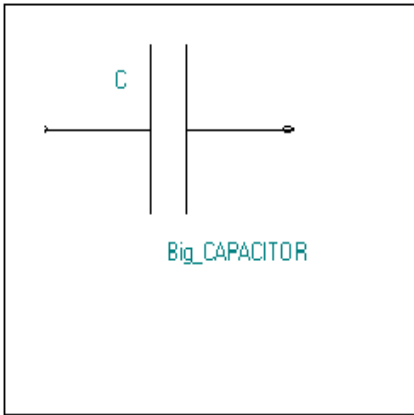

Big_CAPACITOR POLARISED

1 elemento

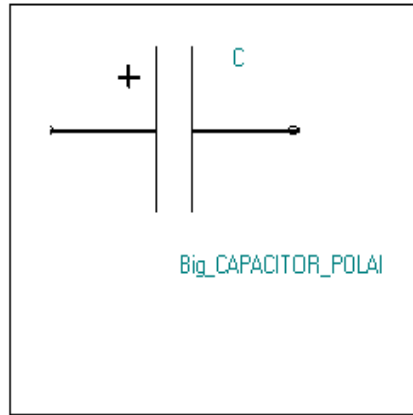

Big_CAPACITOR-ADJUSTABLE

1 elemento

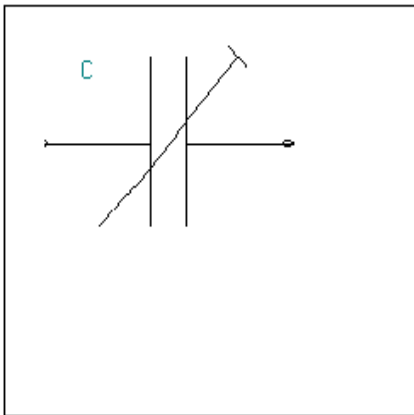

Big_CAPACITOR POLARISED OLD TYPE

1 elemento

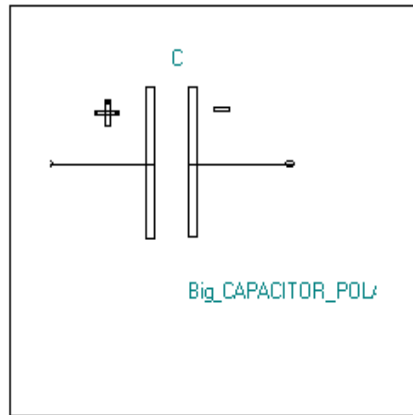

Big_CAPACITOR DIFFERENTIAL

1 elemento

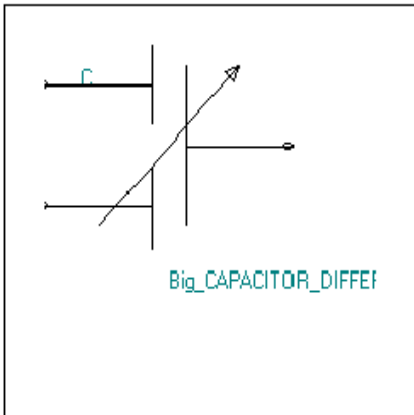

Big_DIODE-Array Bridge2pulse

1 elemento

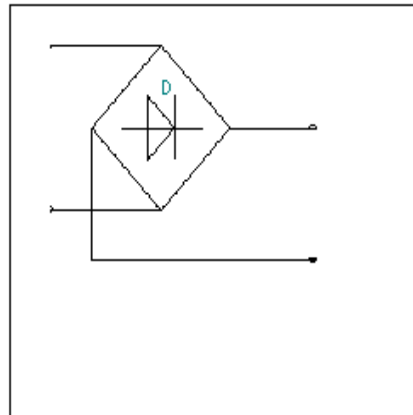

Catálogo de Componentes

4/6/2010 00:34:47

Biblioteca: SymbolsSimilarEN60617+oldDIN617-Rev1Página:13

Big_DIODE-STANDARD

1 elemento

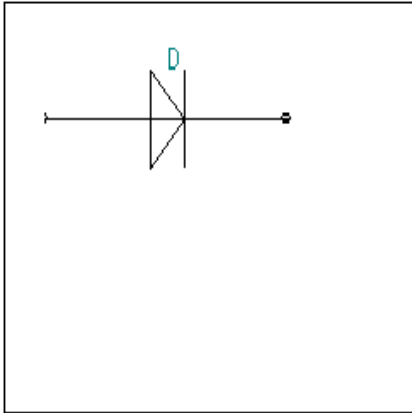

Big_DIODE_2xArrav CommonCathode

1 elemento

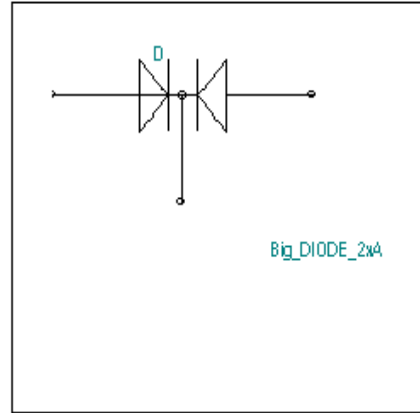

Big_DIODE-SUPPRESSOR-BIPOLAR

1 elemento

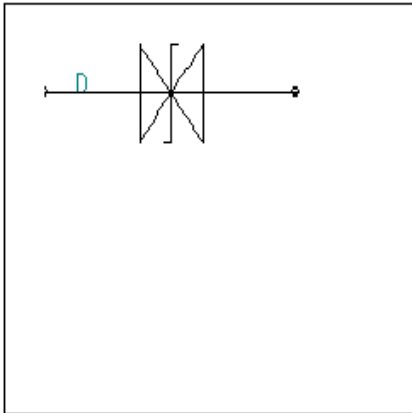

Big_DIODE_BACKWARD

1 elemento

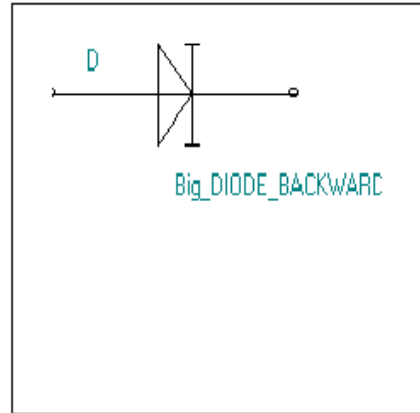

Big_DIODE_2xArrav CommonAnode

1 elemento

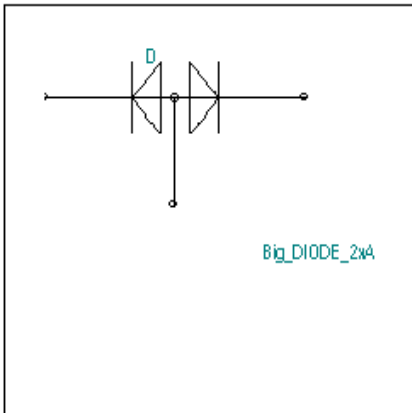

Big_Diode_Current Limitin

1 elemento

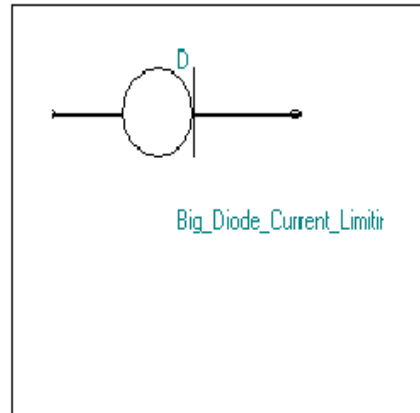

Big_DIODE_LIGHT-EMITTING LED

1 elemento

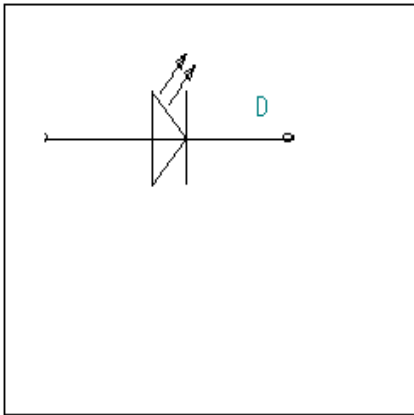

Big_DIODE_TUNNELEFFECT

1 elemento

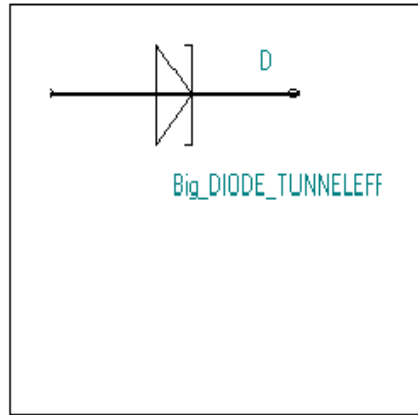

Big_DIODE_PHOTODIODE

1 elemento

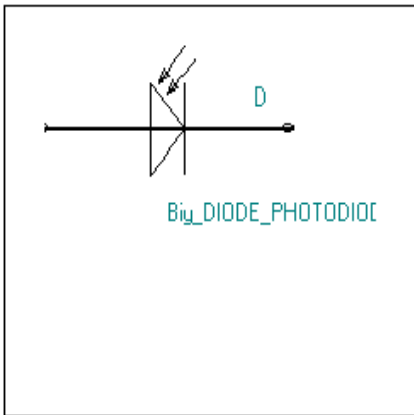

Big_DIODE_VARACTOR-CAPACITANCE

1 elemento

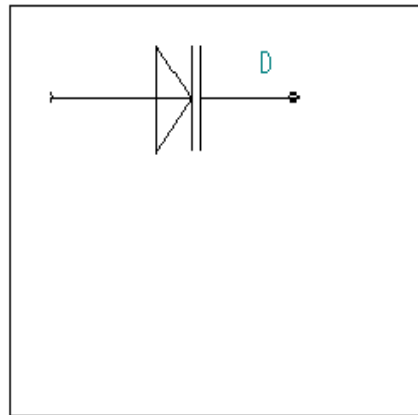

Big_DIODE_SCHOTTKY

1 elemento

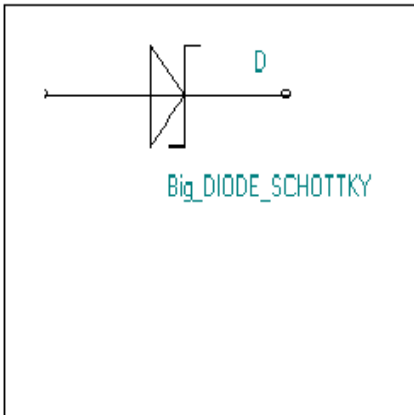

Big_DIODE_ZENFR-DIODE

1 elemento

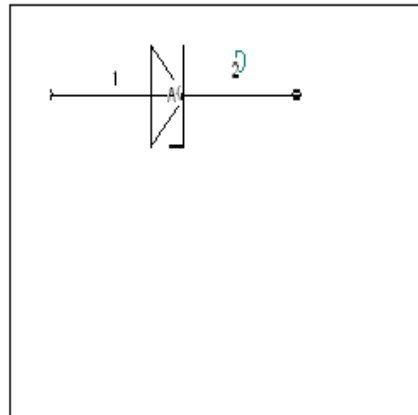

Catálogo de Componentes

4/6/2010 00:34:47

Biblioteca: SymbolsSimilarEN60617+oldDIN617-Rev1Página:15

Big_ELECTRET

1 elemento

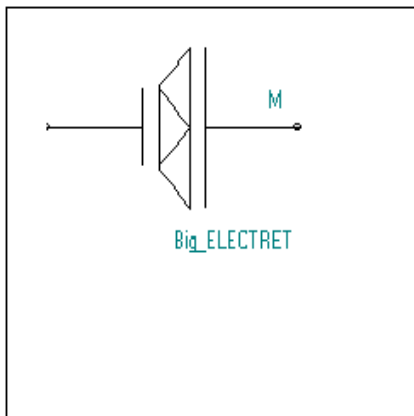

Big_GND-I

1 elemento

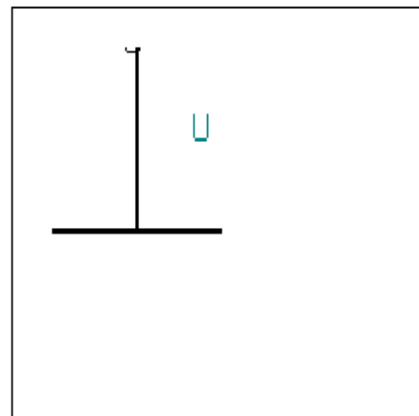

Big_FUSE

1 elemento

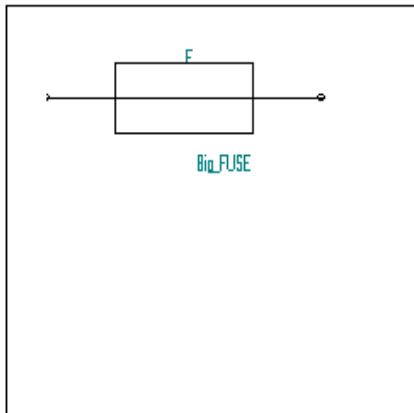

Big_GND-II

1 elemento

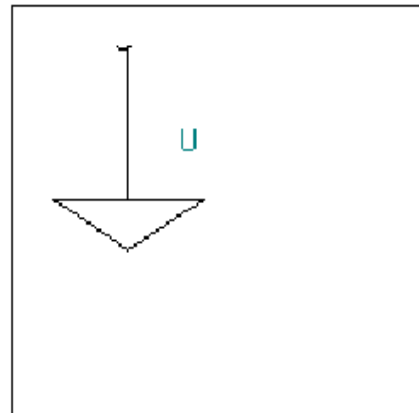

Big_GND

1 elemento

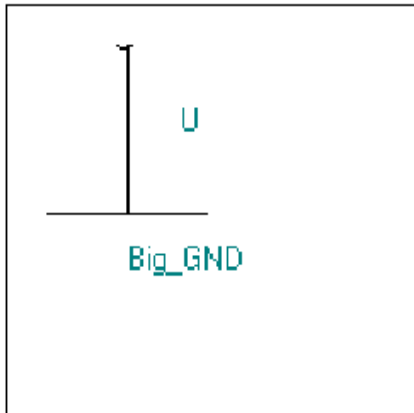

Big_GND-III

1 elemento

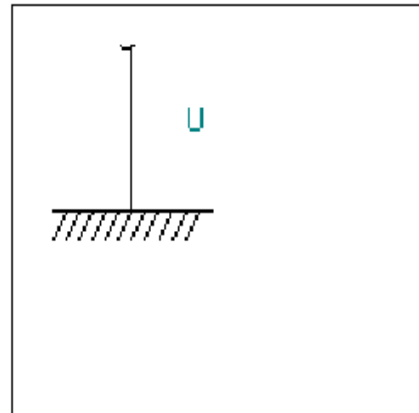

Big_GND-PE

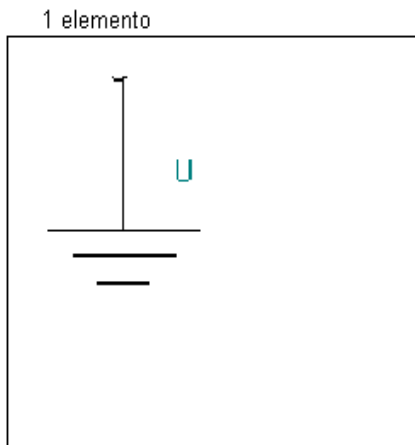

Big_INDUCTANCE OLD TYPE CORE

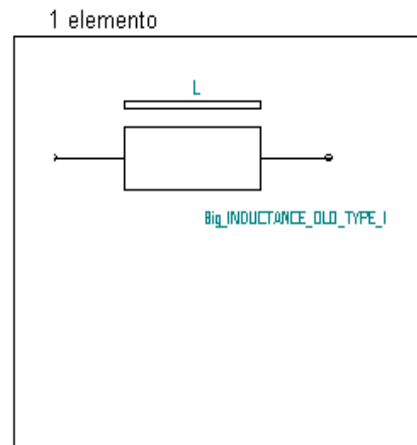

Big_INDUCTANCE

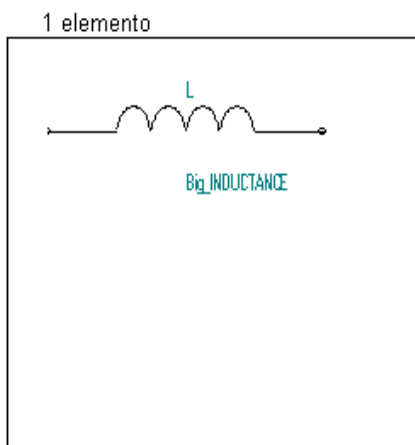

Big_INDUCTANCE OLD TYPE CORE WIHT GAP

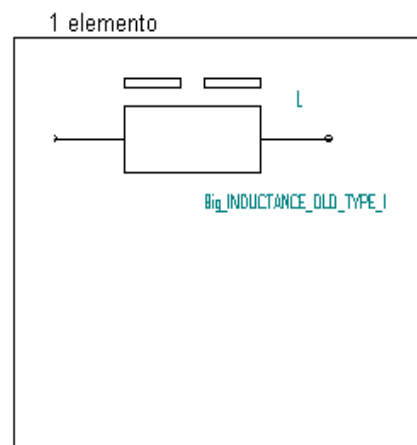

Big_INDUCTANCE OLD TYPE

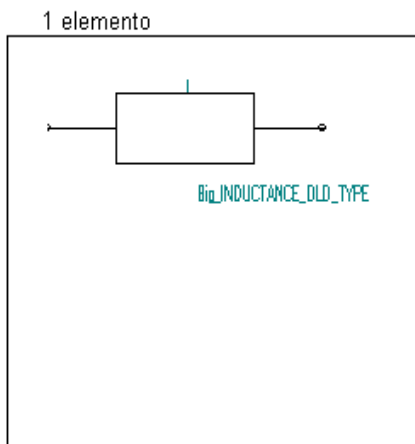

Big_INDUCTANCE OLD TYPE VARIARIF

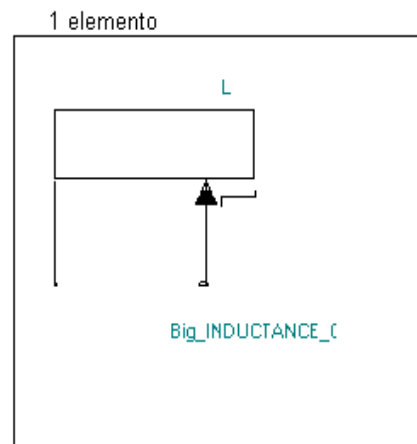

Catálogo de Componentes

4/6/2010 00:34:48

Biblioteca: SymbolsSimilarEN60617+oldDIN617-Rev1Página:17

Big_LIGHTBULB

1 elemento

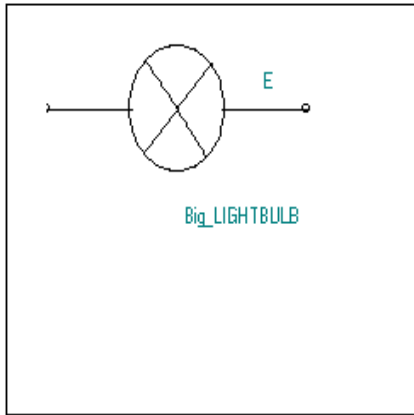

Big_PIEZO-ELEMENT-2 TERMINAL

1 elemento

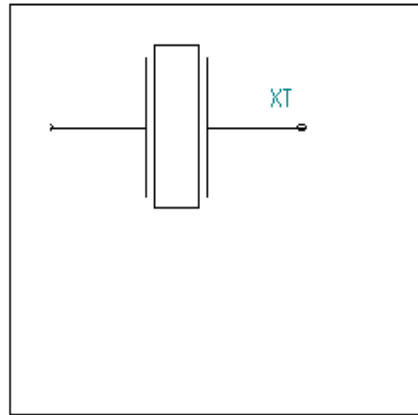

BIG_MEASUREMENT POINT Round

1 elemento

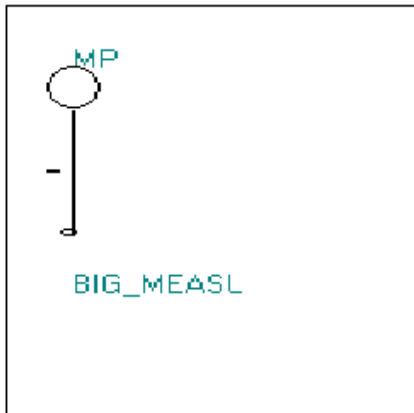

Big_PIEZO-ELEMENT-3 TERMINAL

1 elemento

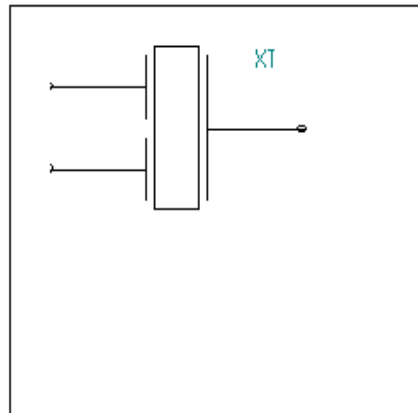

BIG_MEASUREMENT POINT Square

1 elemento

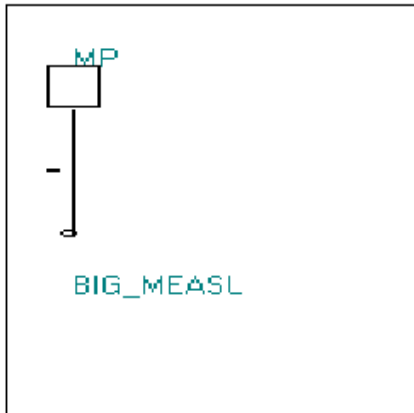

Big_RELAY-1XCHANGF SPDT

1 elemento

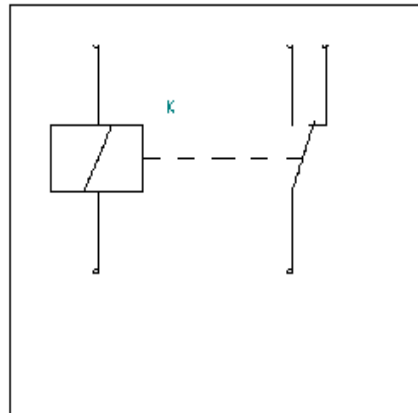

Big_RELAY-1XON SPST

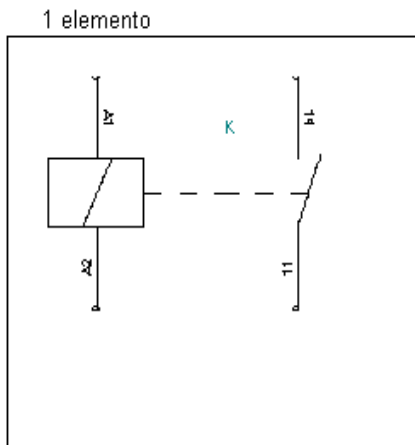

Big_RESISTOR

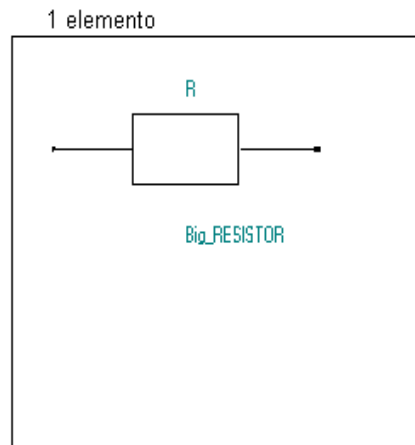

Big_RELAY-2XCHANGE DPDT

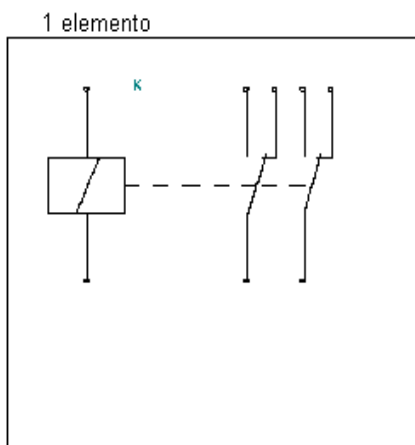

Big_RESISTOR-ADJUSTABLE

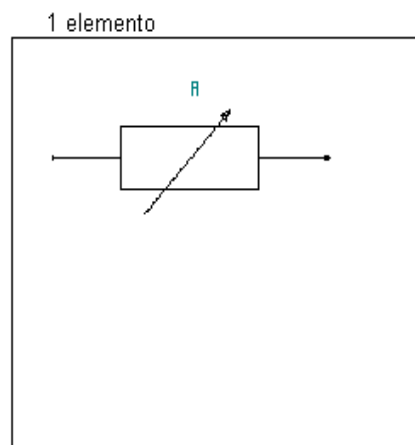

Big_RELAY-2XON DPST

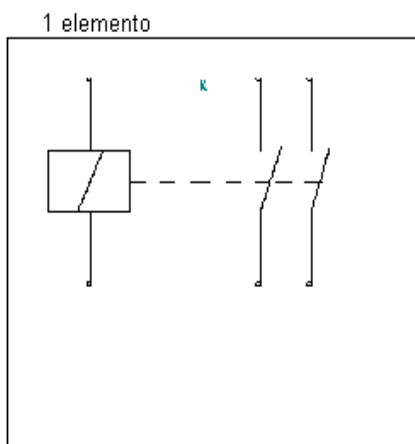

Big_RESISTOR_LIGHT DEPENDENT

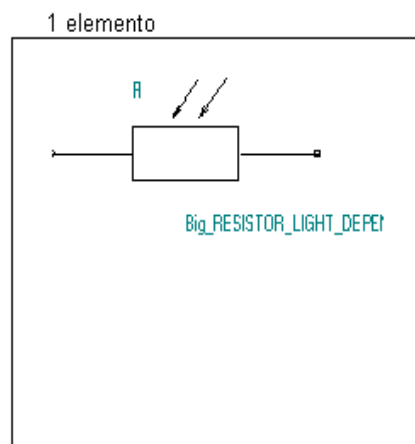

Catálogo de Componentes

4/6/2010 00:34:48

Biblioteca: SymbolsSimilarEN60617+oldDIN617-Rev1Página:19

Big_RESISTOR_THERMISTOR NTC

1 elemento

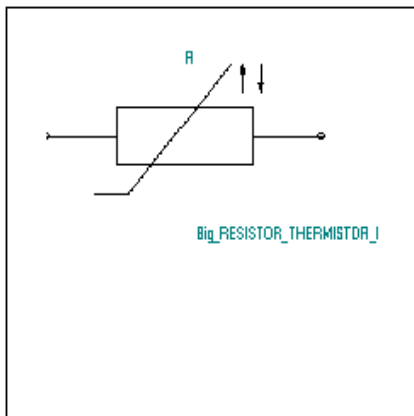

Big_RESISTOR_Voltage-Dependent-Resistor Varistor

1 elemento

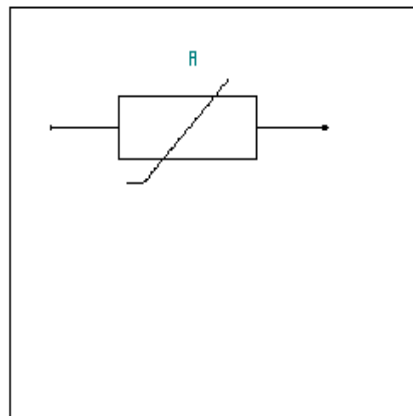

Big_RESISTOR_THERMISTOR PTC

1 elemento

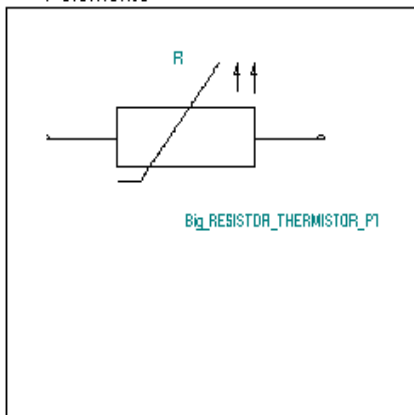

Big_SWITCH-1XCHANGE

1 elemento

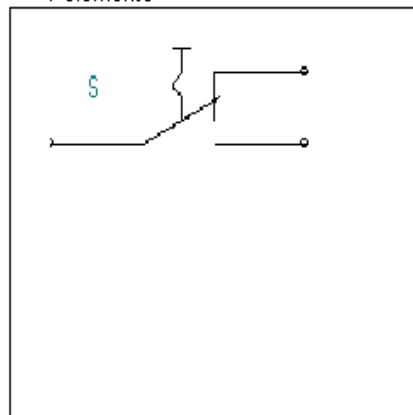

Big_RESISTOR_VARIABLE POTENTIOMETER

1 elemento

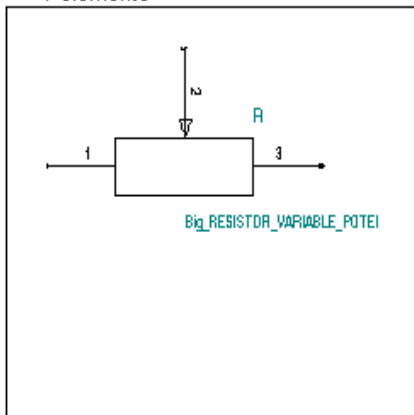

Big_SWITCH-1XON

1 elemento

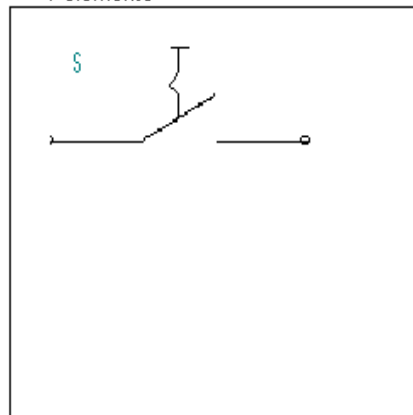

Big_SWITCH-2XCHANGE

1 elemento

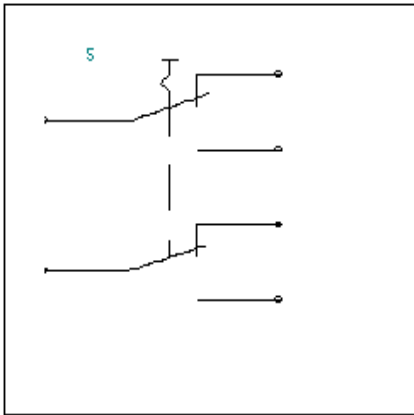

Big_SYMBOL-ARROW.VOLTAGE

1 elemento

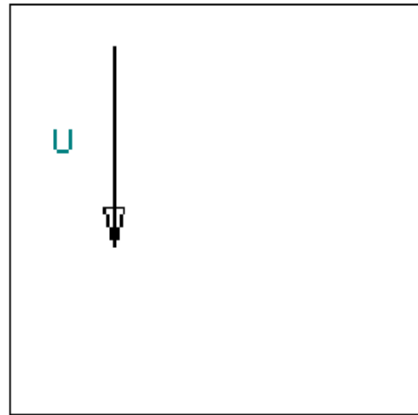

Big_SWITCH-2XON

1 elemento

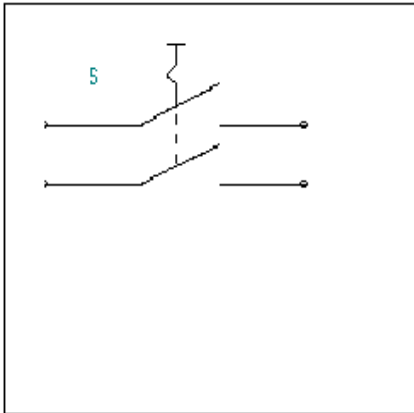

~BIG_SYMBOL_CC-Attribution

1 elemento

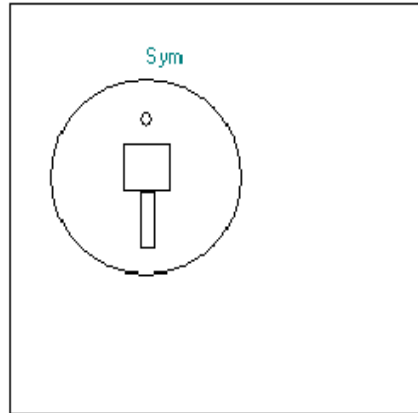

Big_SYMBOL-ARROW.CURRENT

1 elemento

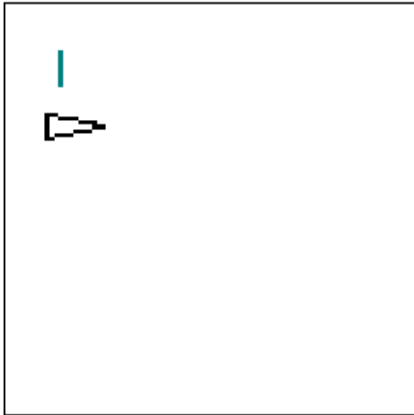

~BIG_SYMBOL_CC-Noncommercial

1 elemento

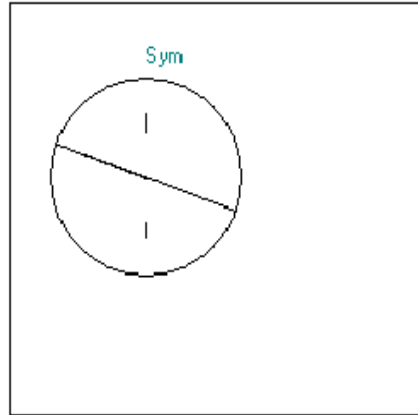

~BIG_SYMBOL_CC-ShareAlike

1 elemento

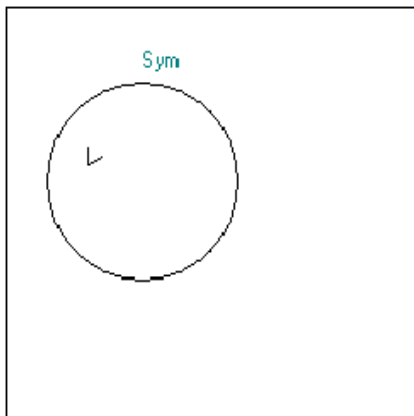

~BIG_SYMBOL_GNU-GPL

1 elemento

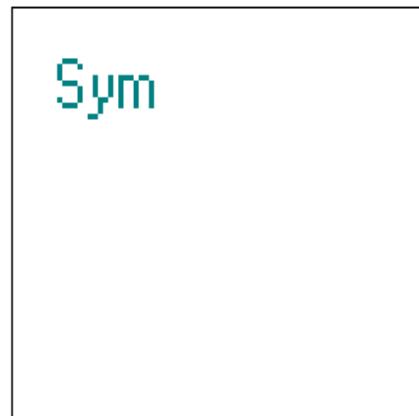

~BIG_SYMBOL_CREATIVECOMMONS Tvo1

1 elemento

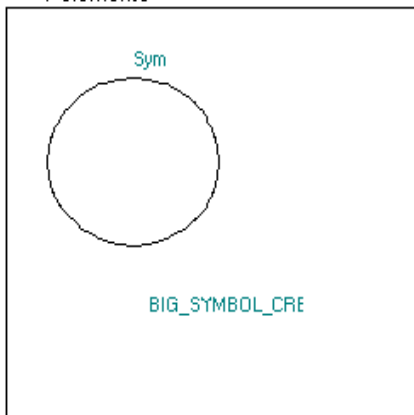

Big_Terminal_Block-10Pin

1 elemento

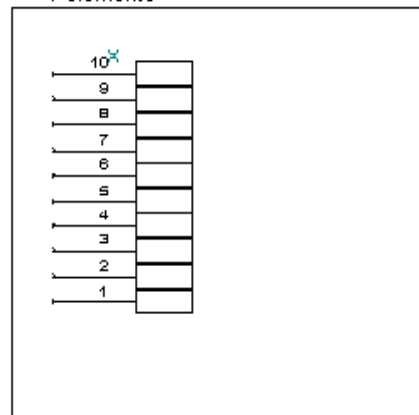

~BIG_SYMBOL_CRFATIVFCOMMONS Tvo2

1 elemento

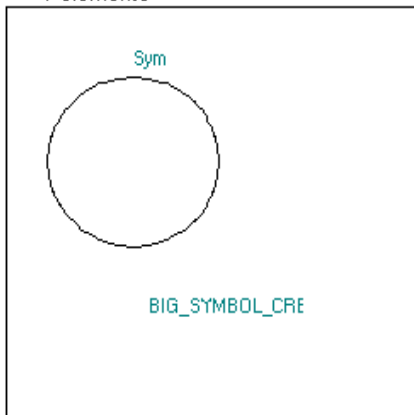

Big_Terminal_Block-11Pin

1 elemento

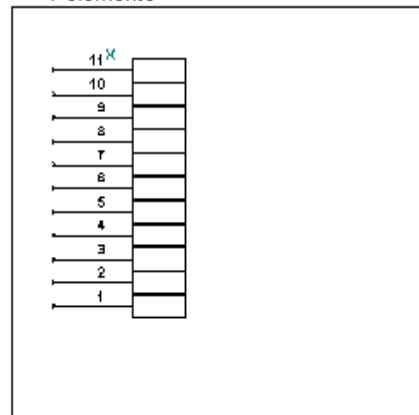

Big_Terminal_Block-12Pin

1 elemento

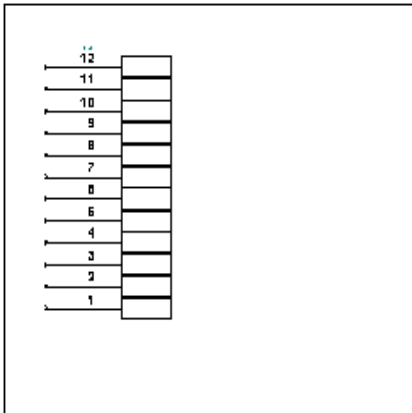

Big_Terminal_Block-15Pin

1 elemento

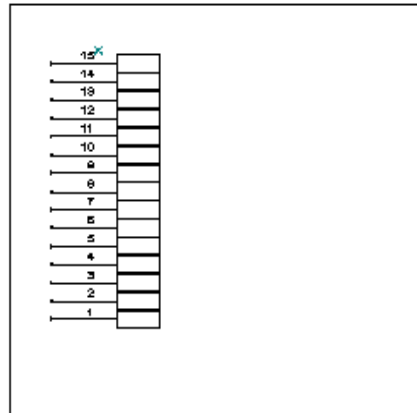

Big_Terminal_Block-13Pin

1 elemento

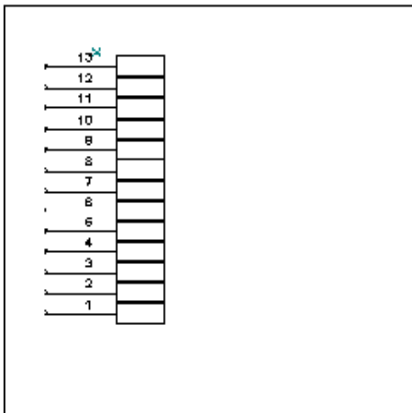

Big_Terminal_Block-16Pin

1 elemento

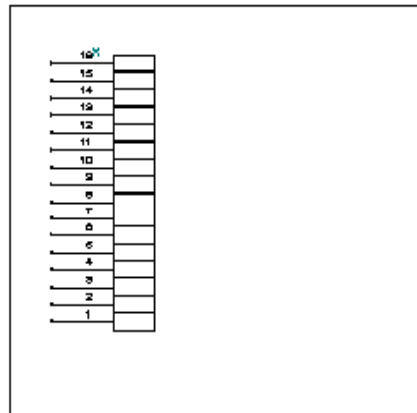

Big_Terminal_Block-14Pin

1 elemento

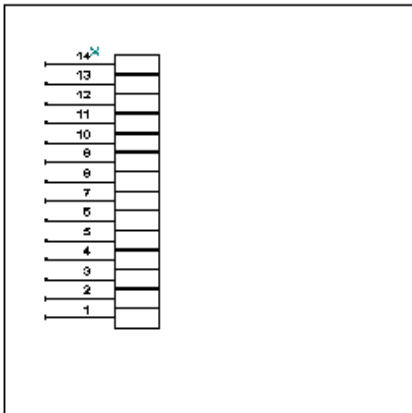

Big_Terminal_Block-1Pin

1 elemento

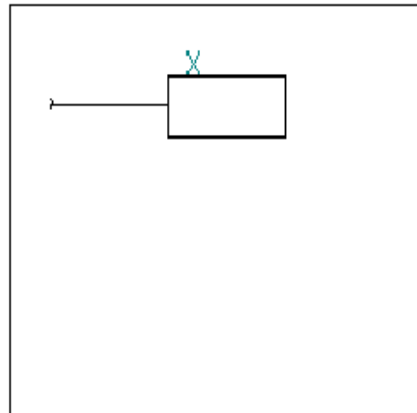

Big_Terminal_Block2Pin

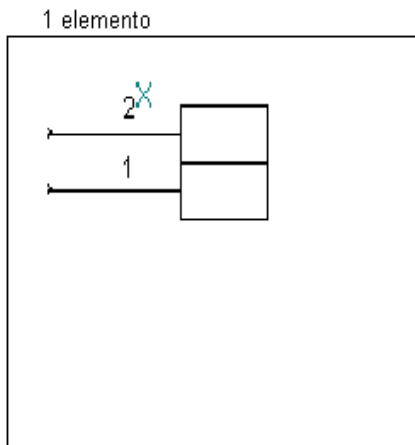

Big_Terminal_Block5Pin

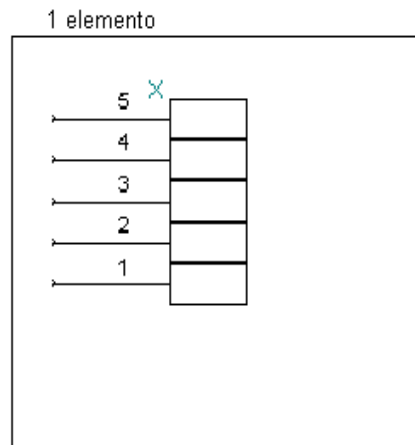

Big_Terminal_Block3Pin

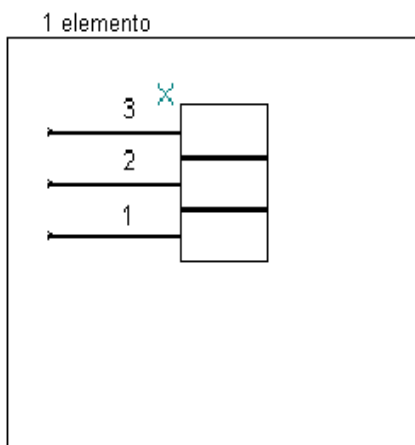

Big_Terminal_Block6Pin

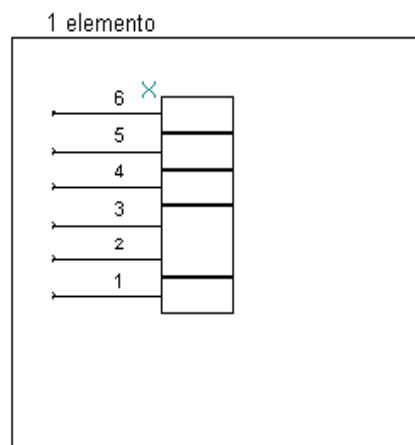

Big_Terminal_Block4Pin

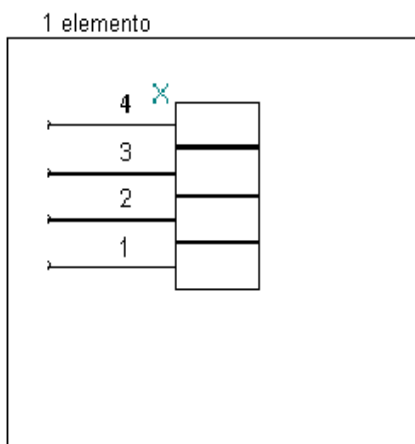

Big_Terminal_Block7Pin

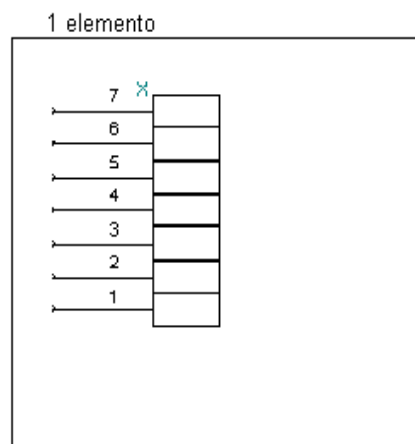

Big_Terminal_Block-8Pin

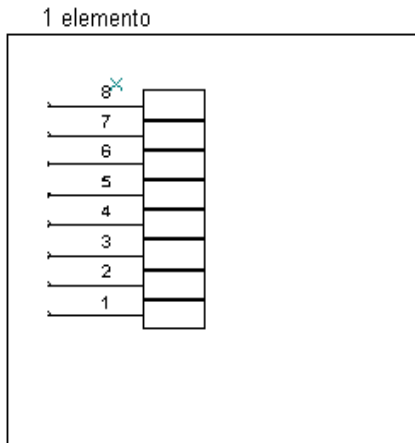

Big_TRANSFORMER

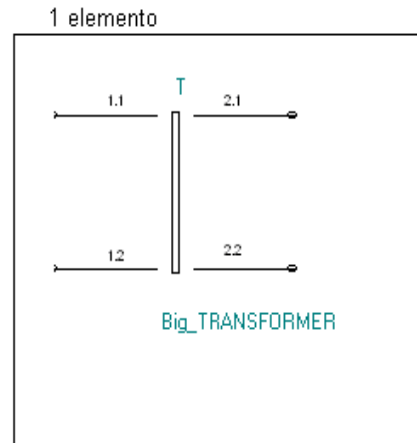

Big_Terminal_Block-9Pin

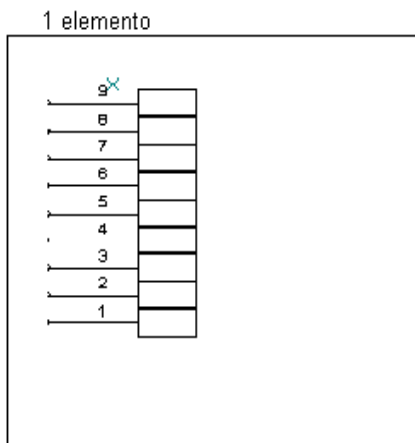

Big_TRANSFORMER-CENTER-TAP-PRIM

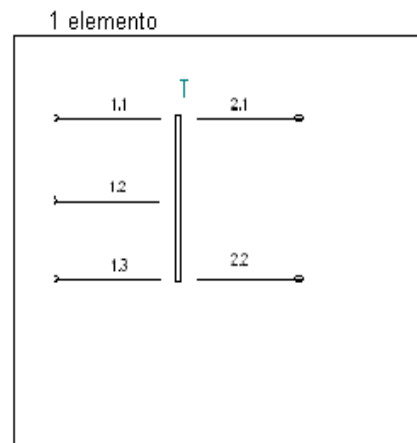

Big_Thyristor-P-Gate

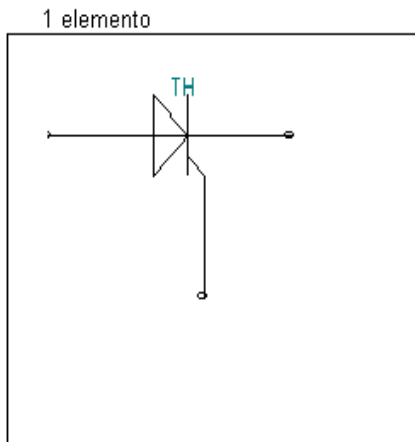

Big_TRANSFORMER-CENTER-TAP-SFC

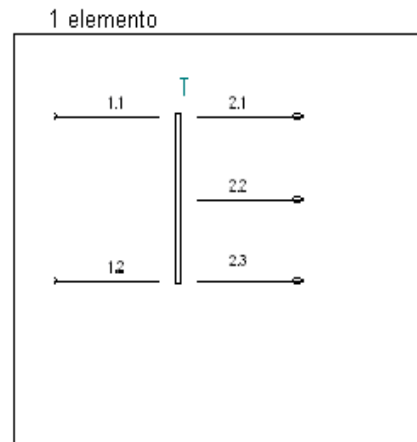

Big_TRANSFORMER-OLD-STYLE

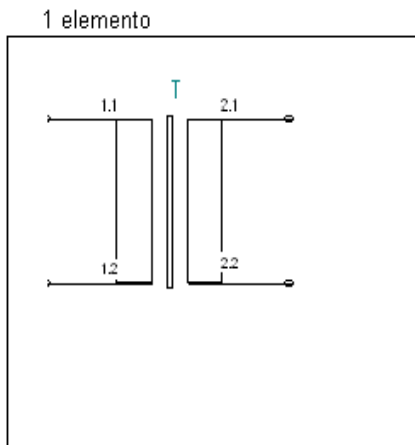

Big_TRANSFORMER-OLD-STYLE I

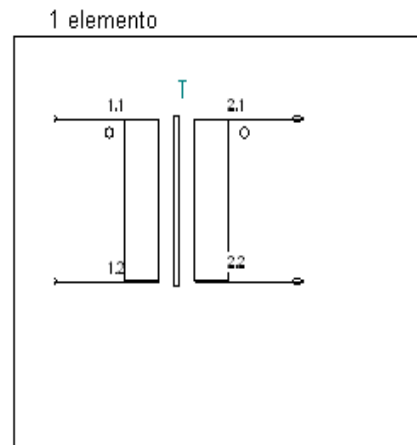

Big_TRANSFORMER-OLD-STYLE-CENTER-TAP-PRIM

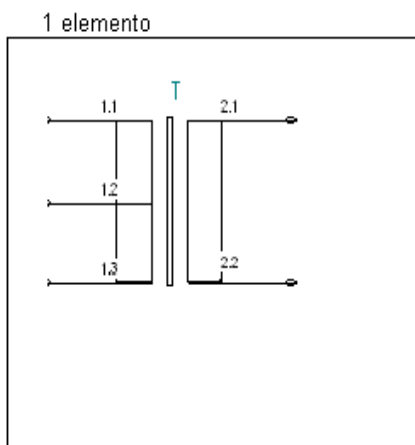

Big_TRANSFORMER-OLD-STYLE II

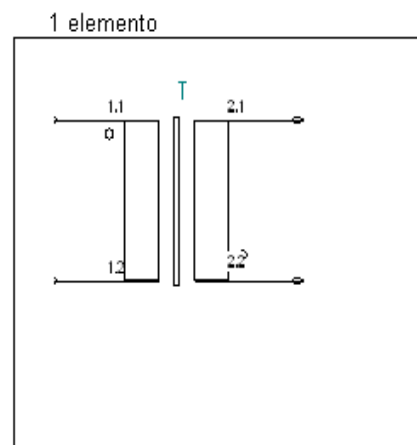

Big_TRANSFORMER-OLD-STYLE-CENTER-TAP-SEC

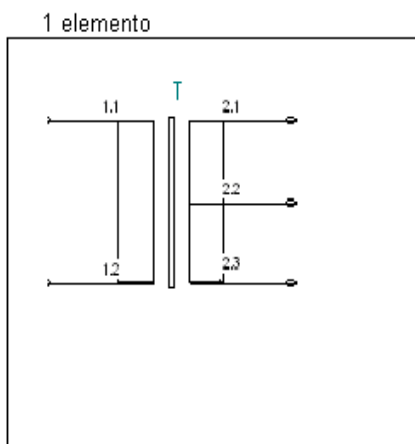

Big_TRANSFORMER I

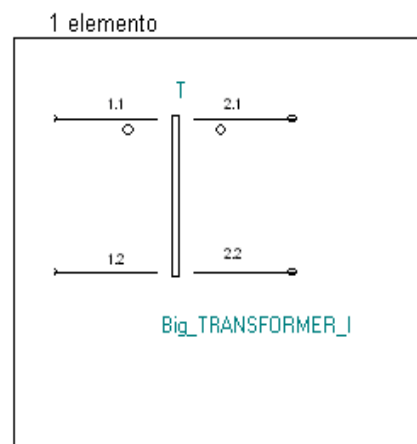

Big_TRANSFORMER_II

1 elemento

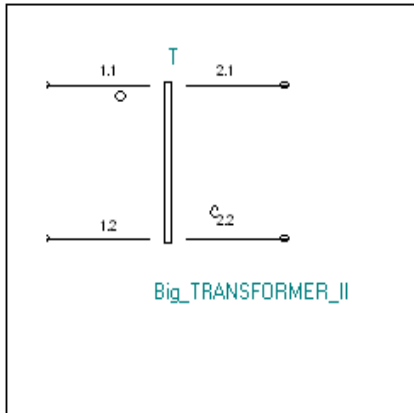

Big_TRANSISTOR-NJFET

1 elemento

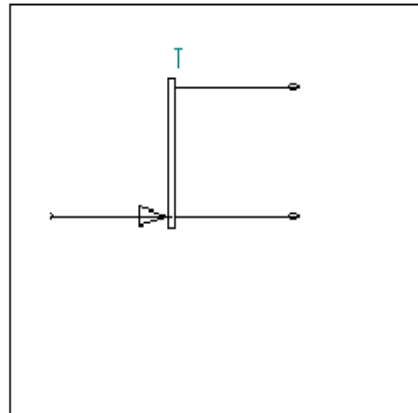

Big_TRANSISTOR-DUAL-GATE-MOSFET

1 elemento

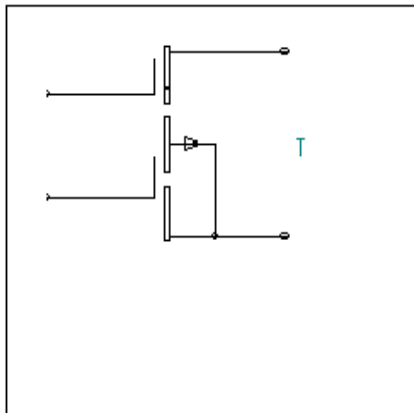

Big_TRANSISTOR-N-MOSFET-DEPLETION

1 elemento

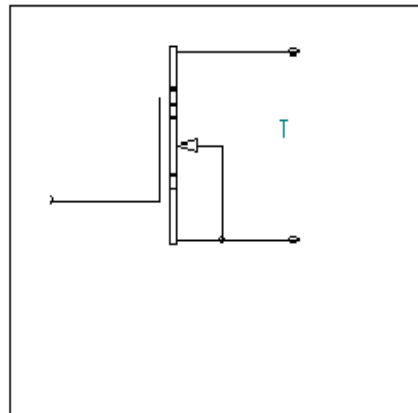

Big_TRANSISTOR-IGBT

1 elemento

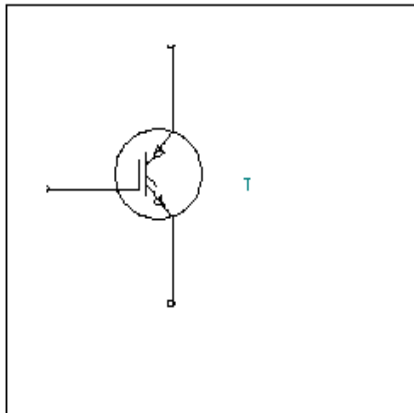

Big_TRANSISTOR-N-MOSFET-FNHANCFMNT

1 elemento

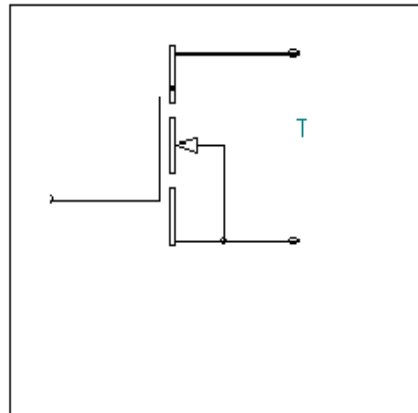

Big_TRANSISTOR-N-UNIUNKTION

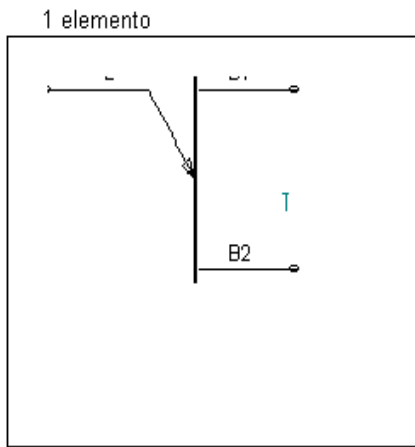

Big_TRANSISTOR-P-JFET

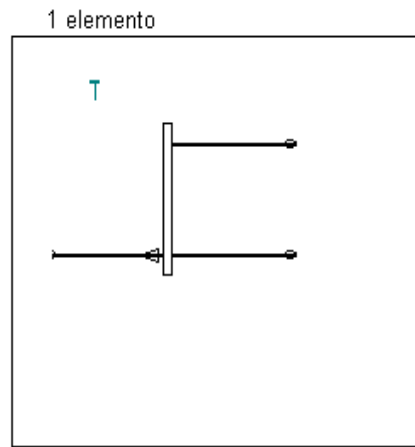

Big_TRANSISTOR-NPN-BIPOLAR

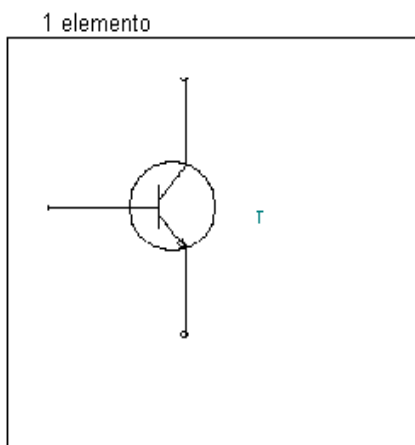

Big_TRANSISTOR-P-MOSFET-DEPLETION

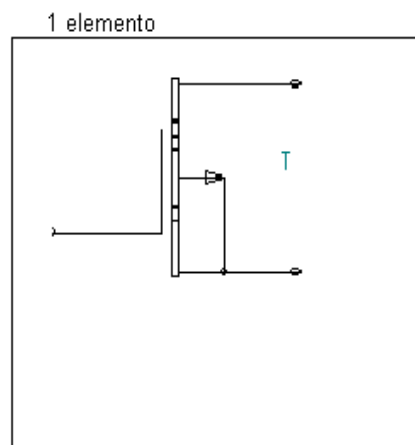

Big_TRANSISTOR-NPN-DARLINGTON-TRANSISTOR

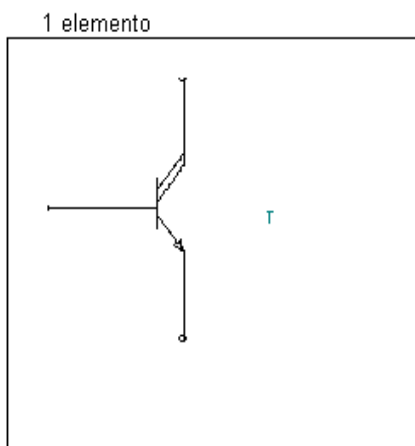

Big_TRANSISTOR-P-MOSFET-FNHANCFMNT

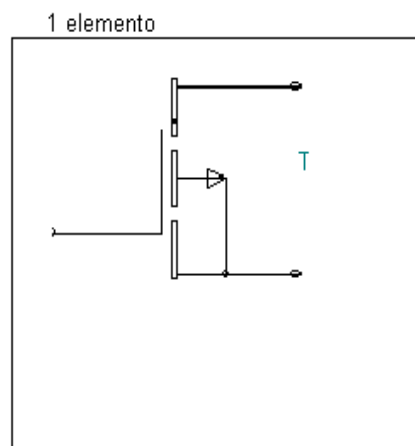

Big_TRANSISTOR-P-UNIJUNKTION

1 elemento

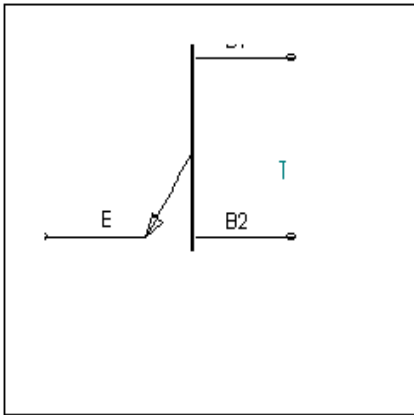

DUMMY_BOARDOUTLINE

1 elemento

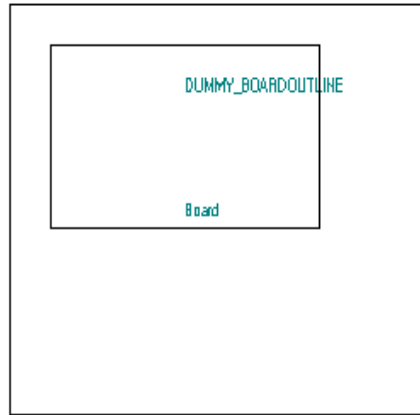

Big_TRANSISTOR-PNP-BIPOLAR

1 elemento

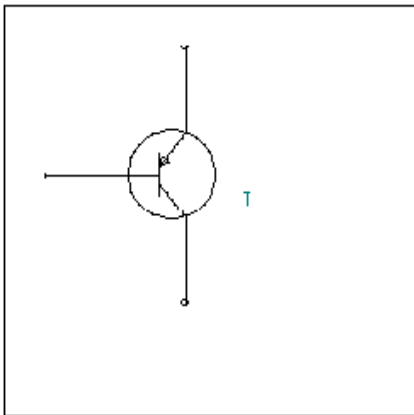

DUMMY_FIDUCIAL

1 elemento

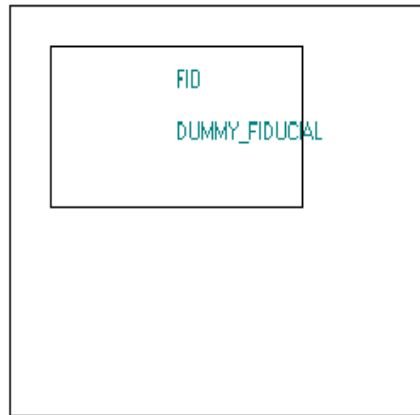

BIG_Triac

1 elemento

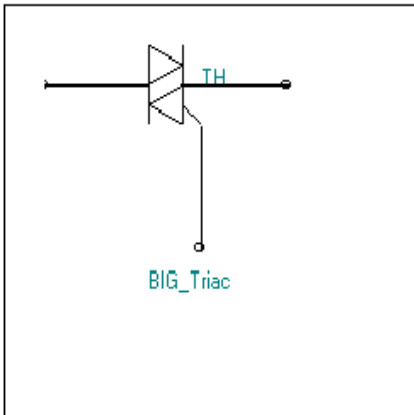

HEATSINK

1 elemento

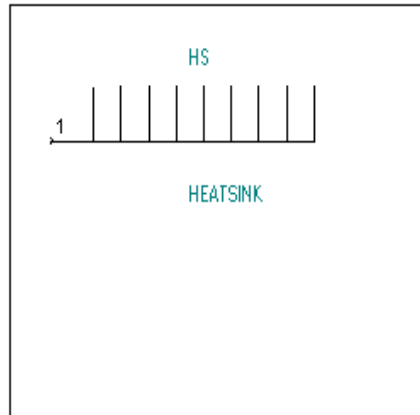

Catálogo de Componentes

4/6/2010 00:34:50

Biblioteca: SymbolsSimilarEN60617+oldDIN617-Rev1Página:19

Small_ANTENNA-DIPOL

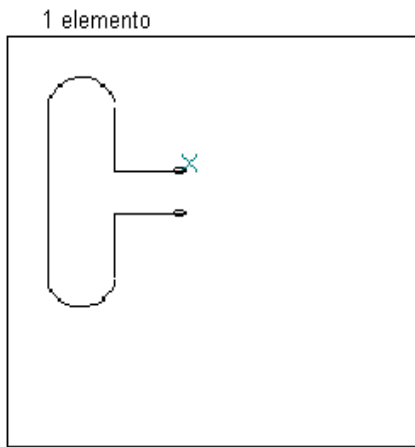

Small_ANTENNA-II

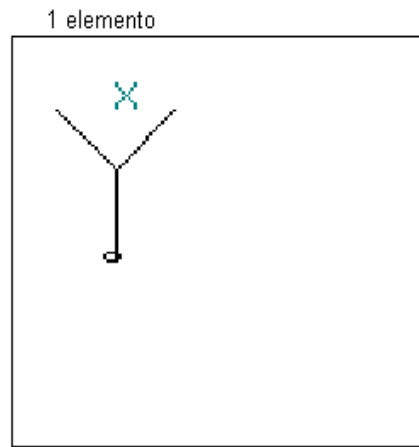

Small_ANTENNA-FRAME

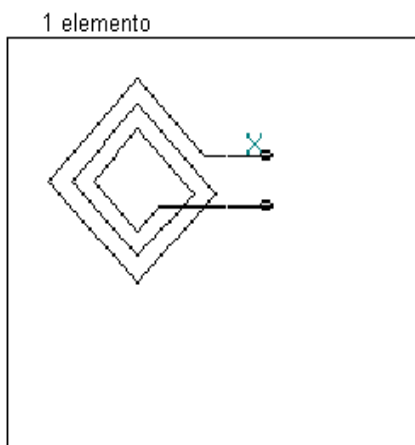

Small_BATTERY

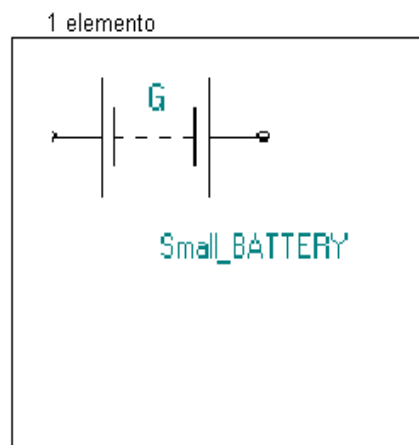

Small_ANTENNA-I

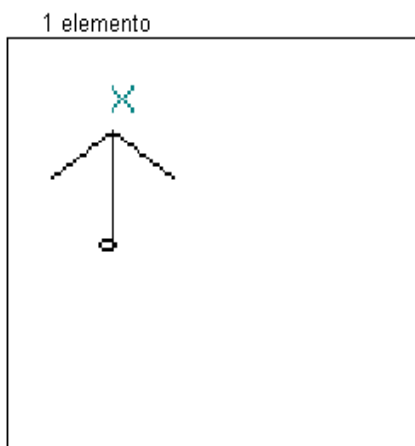

Small_BATTERY-1FI FMFNT

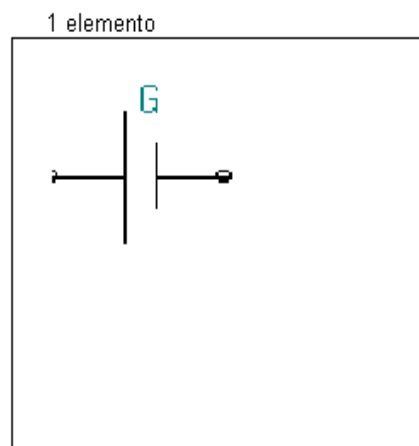

Catálogo de Componentes

4/6/2010 00:34:50

Biblioteca: SymbolsSimilarEN60617+oldDIN617-Rev1Página:120

Small_CAPACITOR

1 elemento

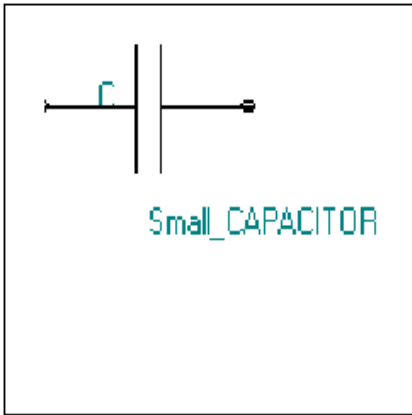

Small_CAPACITOR POLARISED

1 elemento

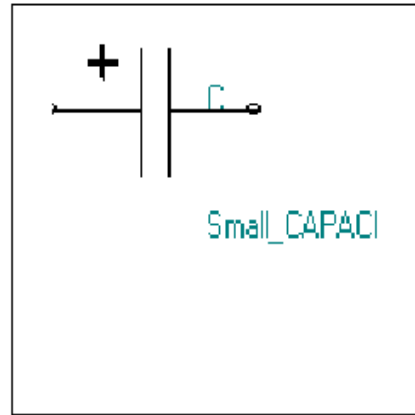

Small_CAPACITOR-ADJUSTABLE

1 elemento

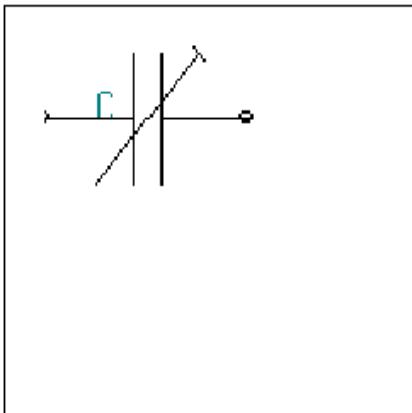

Small_CAPACITOR POLARISED OLD TYPE

1 elemento

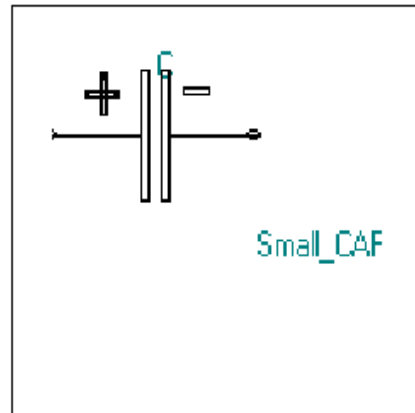

Small_CAPACITOR DIFFERENTIAL

1 elemento

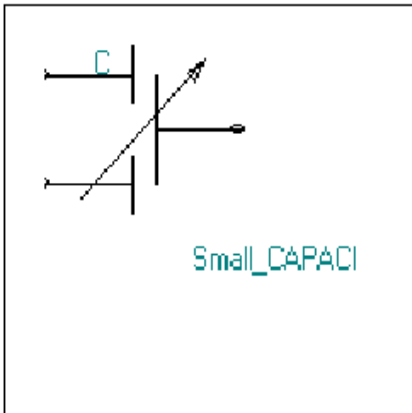

Small_DIODE-2xArrav CommonAnode

1 elemento

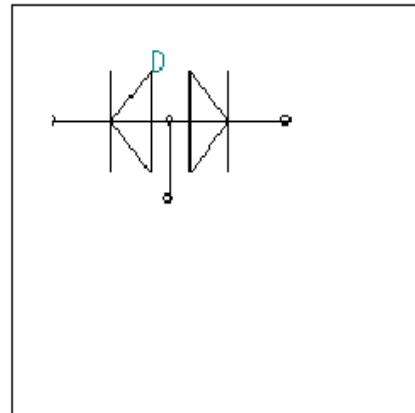

Catálogo de Componentes

4/6/2010 00:34:50

Biblioteca: SymbolsSimilarEN60617+oldDIN617-Rev1Página:1121

Small_DIODE-2xArrav CommonCathode

1 elemento

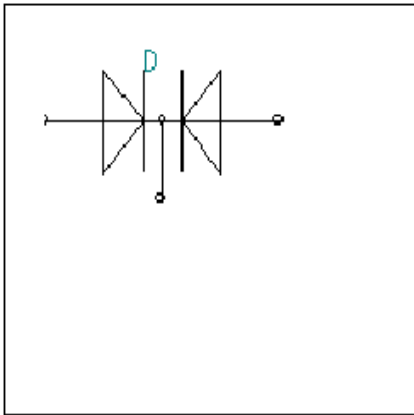

Small_DIODE-STANDARD

1 elemento

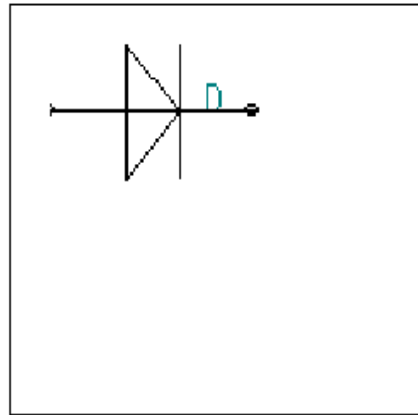

Small_DIODE-Arrav Bridge2pulse

1 elemento

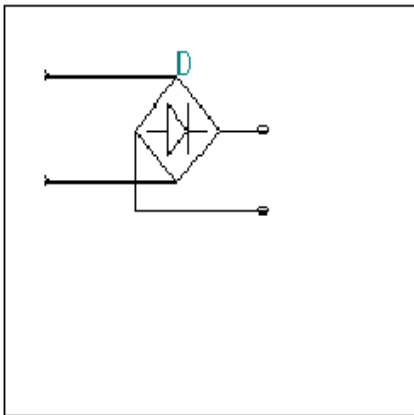

Small_DIODE-SUPPRESSOR-BIPOLAR

1 elemento

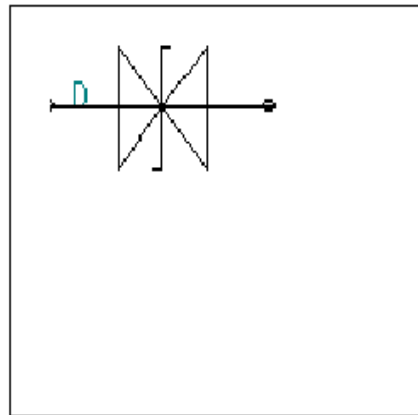

Small_DIODE-Current-Limiting

1 elemento

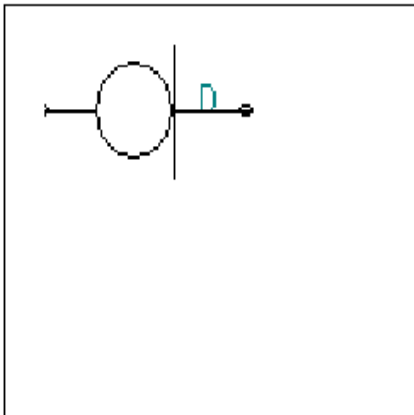

Small_DIODE_BACKWARD

1 elemento

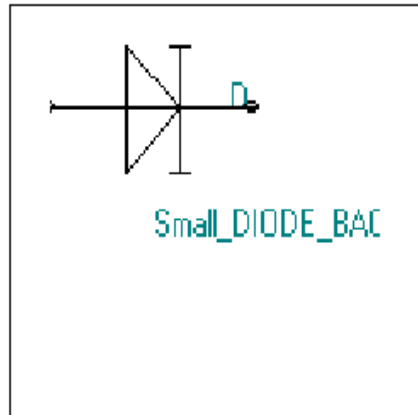

Catálogo de Componentes

4/6/2010 00:34:51

Biblioteca: SymbolsSimilarEN60617+oldDIN617-Rev1Página:122

Small_DIODE_LIGHT-EMITTING LED

1 elemento

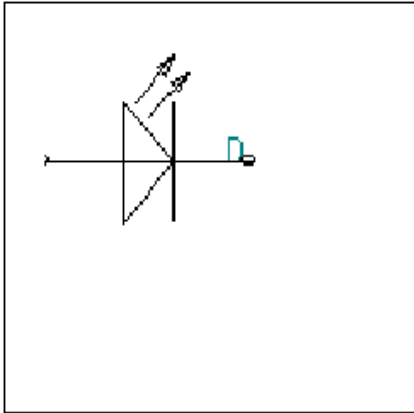

Small_DIODE_TUNNELEFFECT

1 elemento

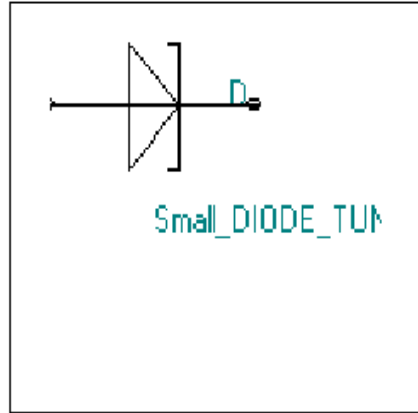

Small_DIODE_PHOTODIODE

1 elemento

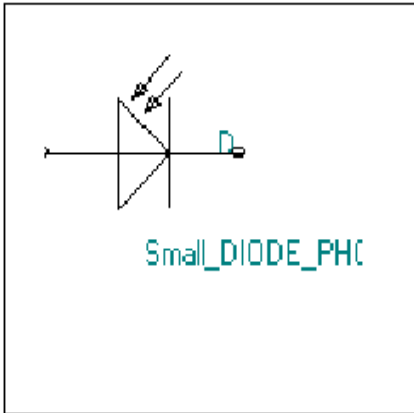

Small_DIODE_VARACTOR-CAPACITANCE

1 elemento

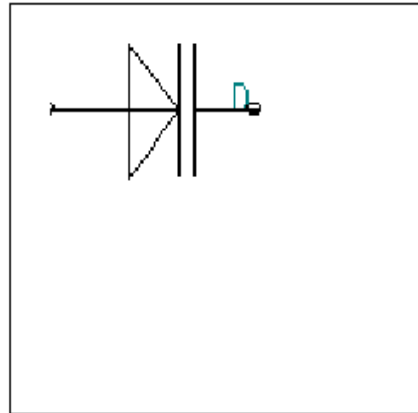

Small_DIODE_SCHOTTKY

1 elemento

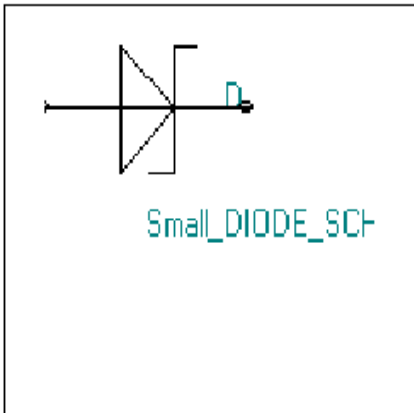

Small_DIODE_ZFNFR-DIODE

1 elemento

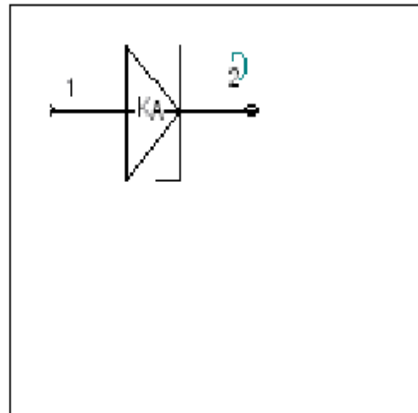

Catálogo de Componentes

4/6/2010 00:34:51

Biblioteca: SymbolsSimilarEN60617+oldDIN617-Rev1Página:123

Small_ELECTRET

1 elemento

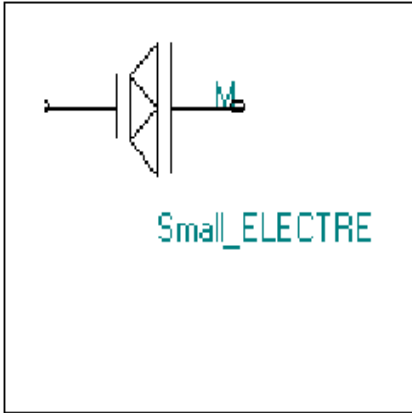

Small_GND-I

1 elemento

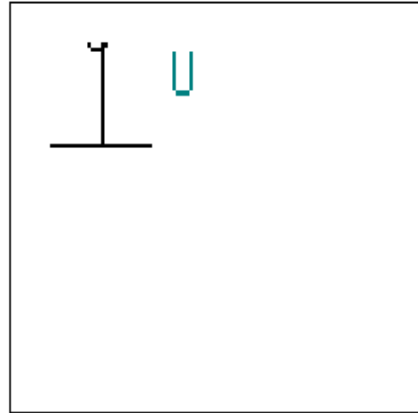

Small_FUSE

1 elemento

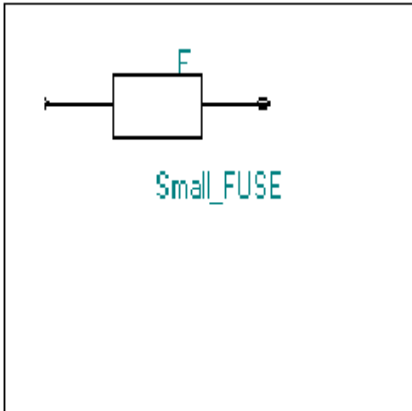

Small_GND-II

1 elemento

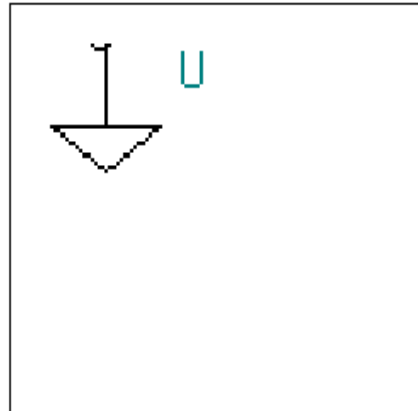

Small_GND

1 elemento

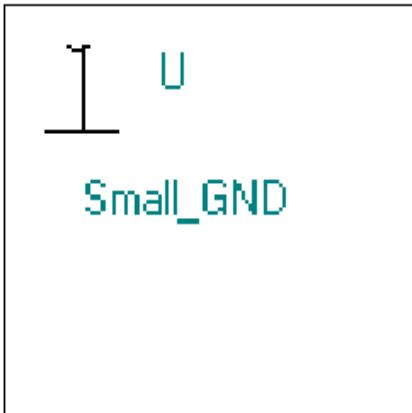

Small_GND-III

1 elemento

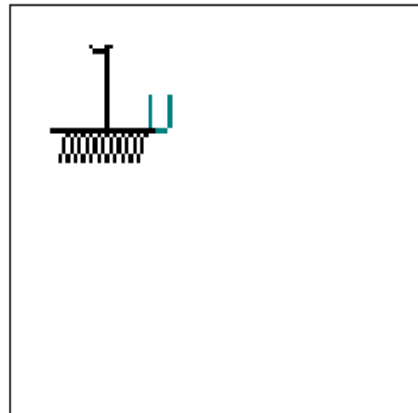

Small_GND-PE

1 elemento

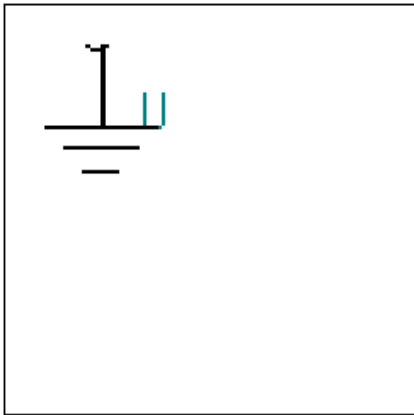

Small_INDUCTANCE OLD TYPE CORE

1 elemento

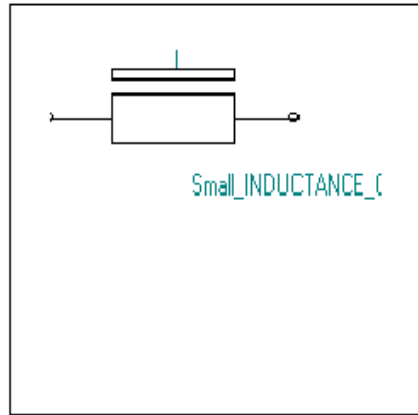

Small_INDUCTANCE

1 elemento

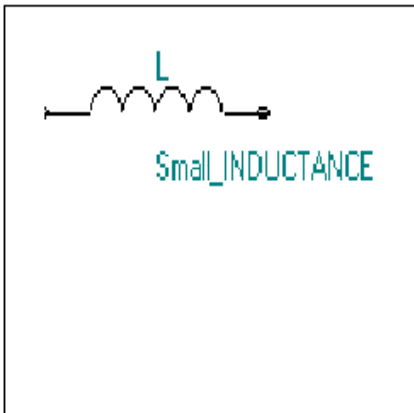

Small_INDUCTANCE OLD TYPE CORE WIHT GAP

1 elemento

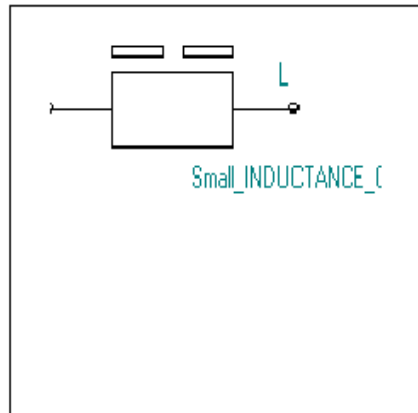

Small_INDUCTANCE OLD TYPE

1 elemento

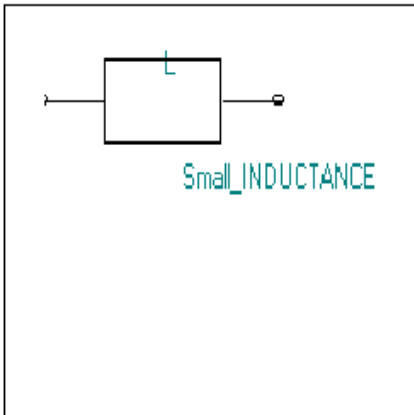

Small_INDUCTANCE OLD TYPE VARIARI F

1 elemento

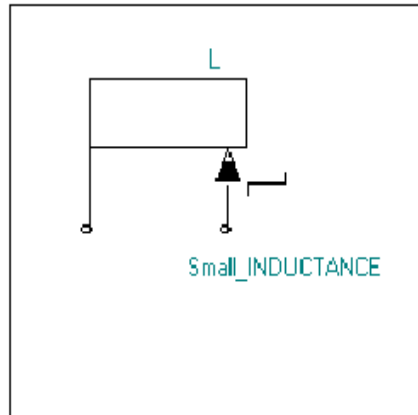

Small_LIGHTBULB

1 elemento

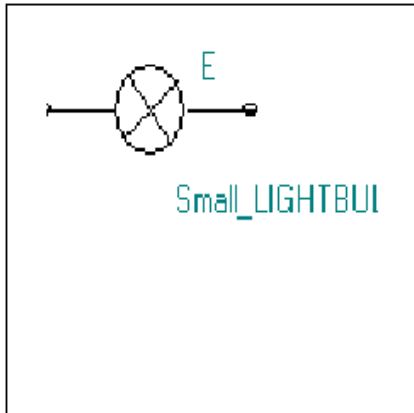

Small_PIEZO-ELEMENT-2 TERMINAL

1 elemento

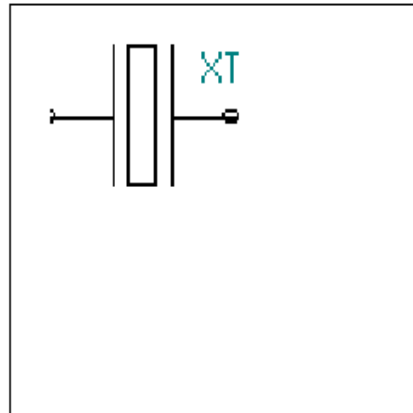

Small_MEASUREMENT POINT Round

1 elemento

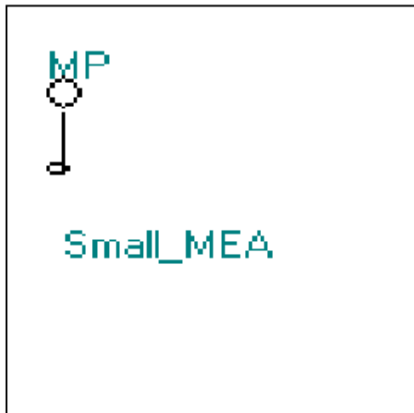

Small_PIEZO-ELEMENT-3 TERMINAL

1 elemento

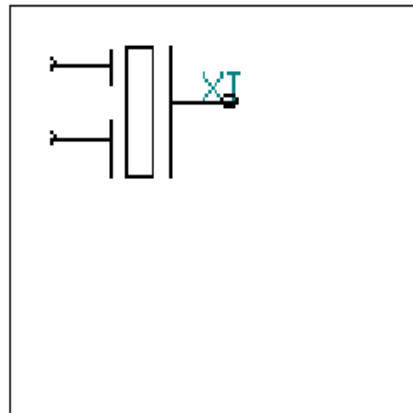

Small_MEASUREMENT POINT Square

1 elemento

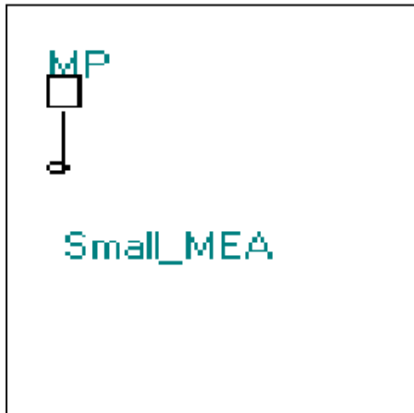

Small_RELAY-1XCHANGF SPDT

1 elemento

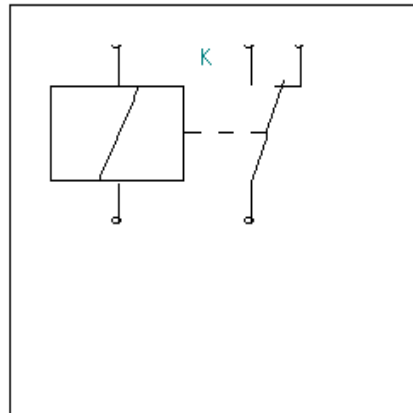

Small_RELAY-1XCLOSED SPST

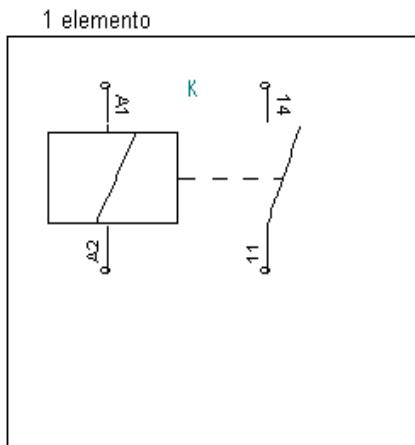

Small_RESISTOR

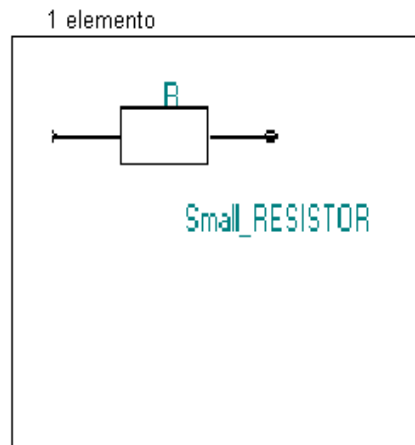

Small_RELAY-2XCHANGE DPDT

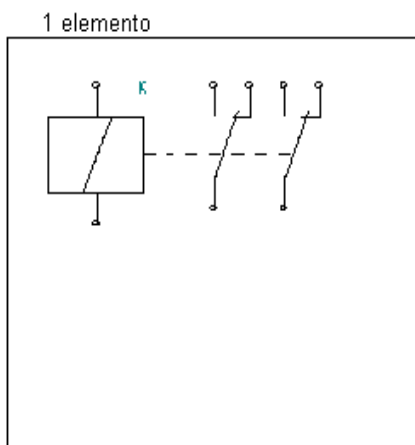

Small_RESISTOR-ADJUSTABLE

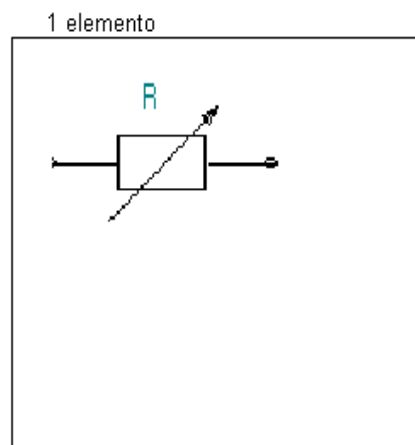

Small_RELAY-2XCLOSED DPST

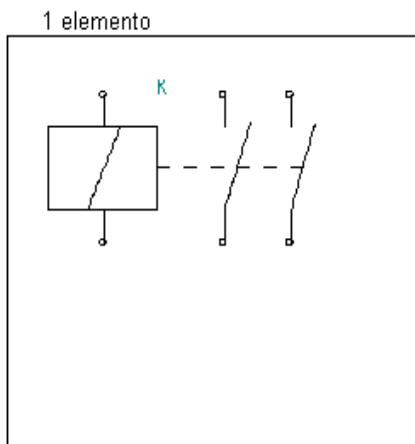

Small_RESISTOR LIGHT DEPENDENT

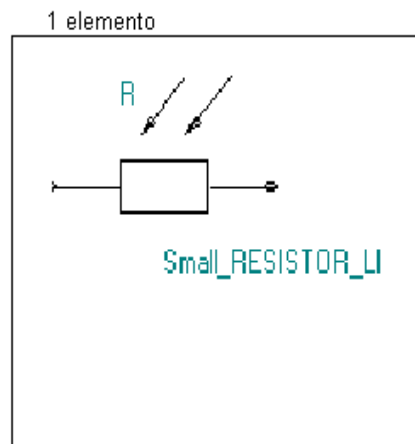

Catálogo de Componentes

4/6/2010 00:34:52

Biblioteca: SymbolsSimilarEN60617+oldDIN617-Rev1Página:127

Small_RESISTOR THERMISTOR NTC

1 elemento

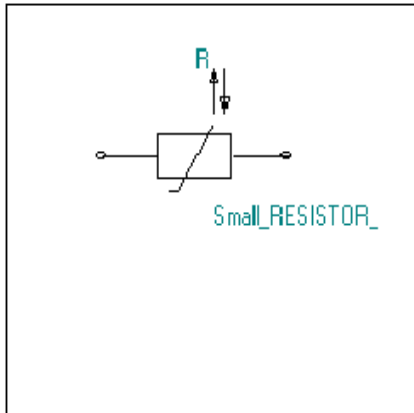

Small_RESISTOR VDR Voltage-Dependent-Resistor Varistor

1 elemento

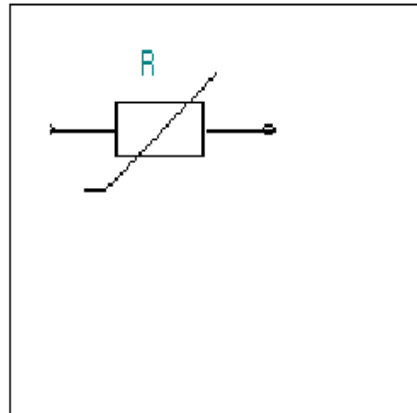

Small_RESISTOR THERMISTOR PTC

1 elemento

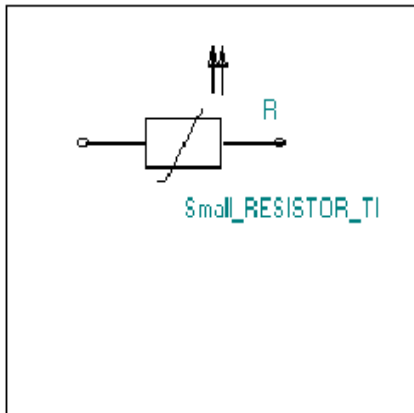

Small_SWITCH-1XCHANGE

1 elemento

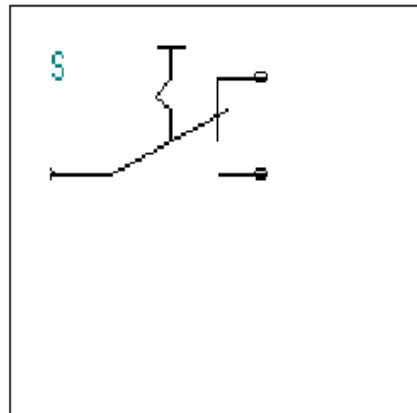

Small_RESISTOR VARIAB F POTENTIOMETER

1 elemento

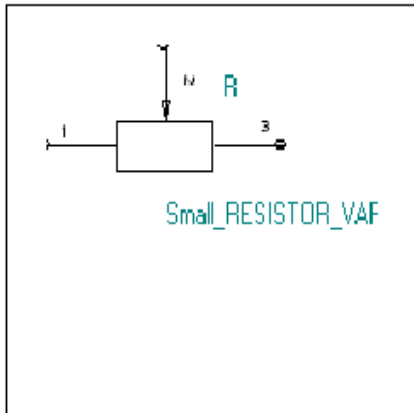

Small_SWITCH-1XON

1 elemento

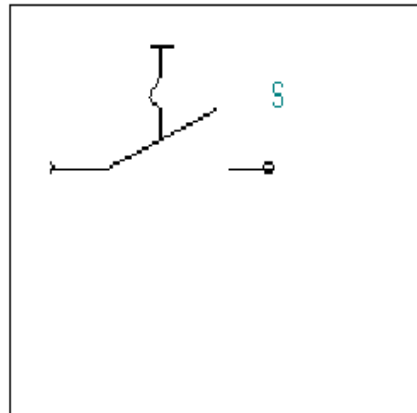

Catálogo de Componentes

4/6/2010 00:34:52

Biblioteca: SymbolsSimilarEN60617+oldDIN617-Rev1Página:128

Small_SWITCH-2XCHANGE

1 elemento

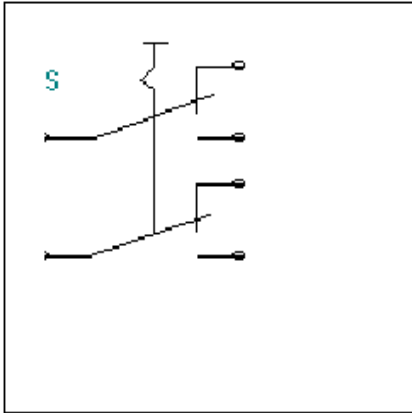

Small_SYMBOL-ARROW-VOLTAGE

1 elemento

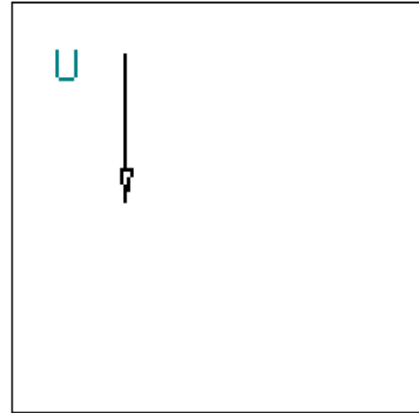

Small_SWITCH-2XON

1 elemento

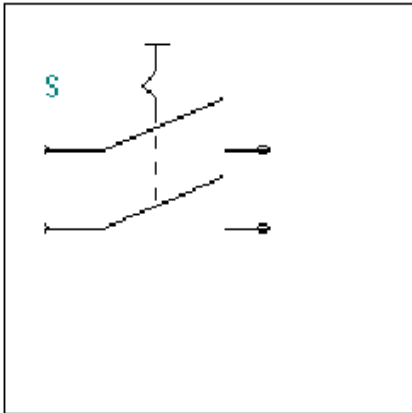

~Small_SYMBOL CC-Attribution

1 elemento

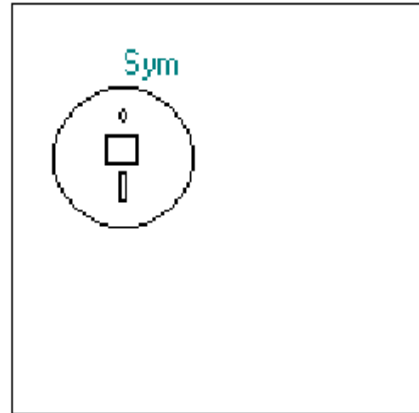

Small_SYMBOL-ARROW-CURRFNT

1 elemento

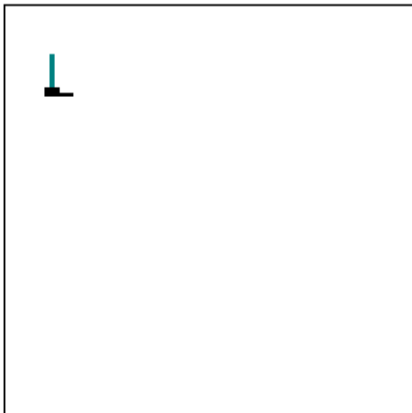

~Small_SYMBOL CC-Noncommercial

1 elemento

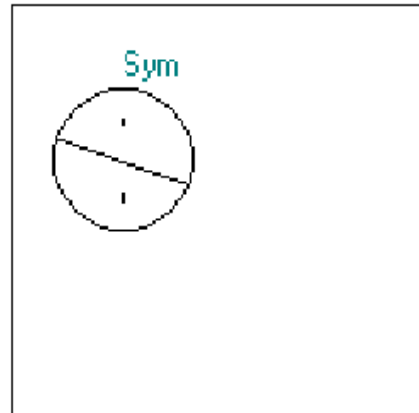

~Small_SYMBOL CC-ShareAlike

1 elemento

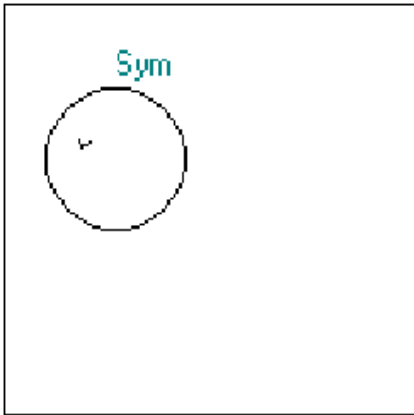

~Small_SYMBOL GNU-GPL

1 elemento

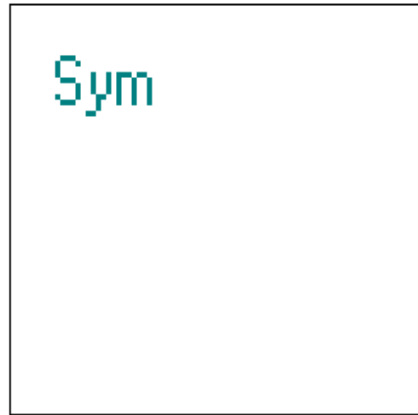

~Small_SYMBOL CREATIVECOMMONS Tvp1

1 elemento

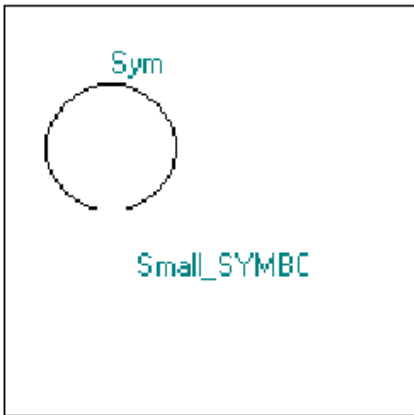

Small_Terminal Block-10Pin

1 elemento

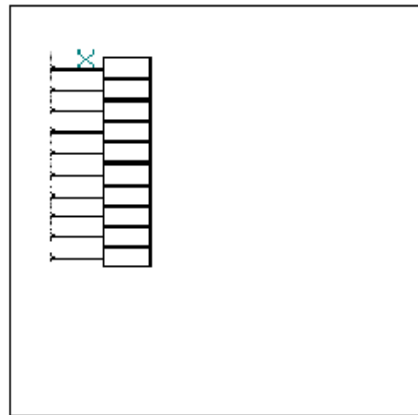

~Small_SYMBOL CREATIVECOMMONS Tvp2

1 elemento

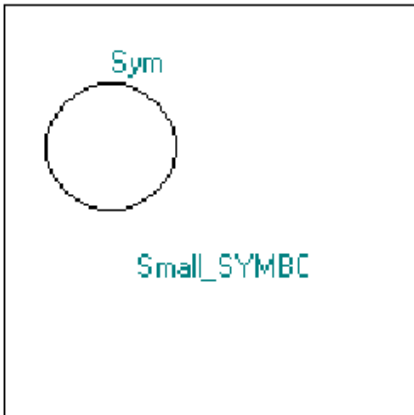

Small_Terminal Block-11Pin

1 elemento

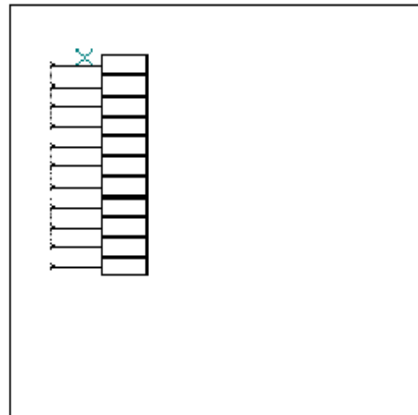

Small_Terminal Block-12Pin

1 elemento

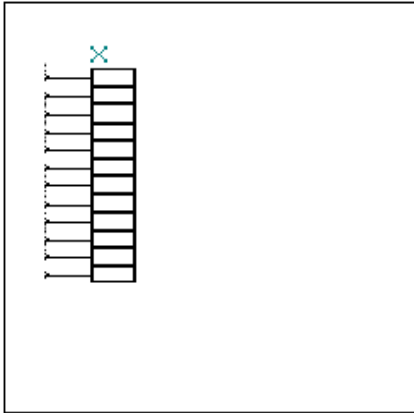

Small_Terminal Block-15Pin

1 elemento

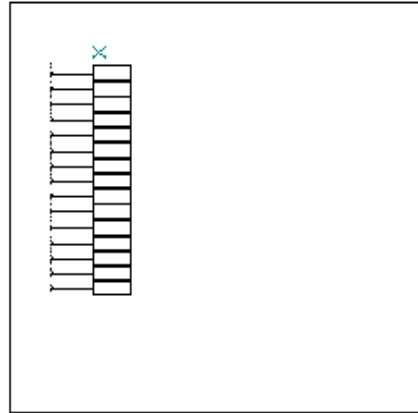

Small_Terminal Block-13Pin

1 elemento

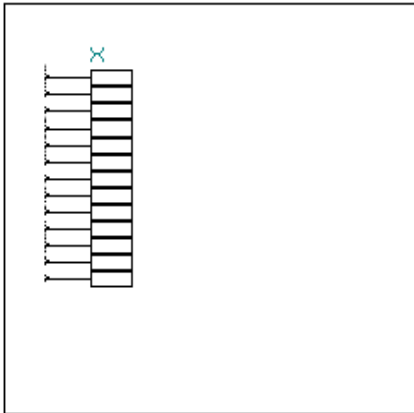

Small_Terminal Block-16Pin

1 elemento

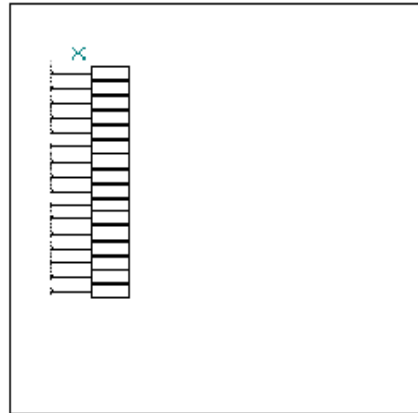

Small_Terminal Block-14Pin

1 elemento

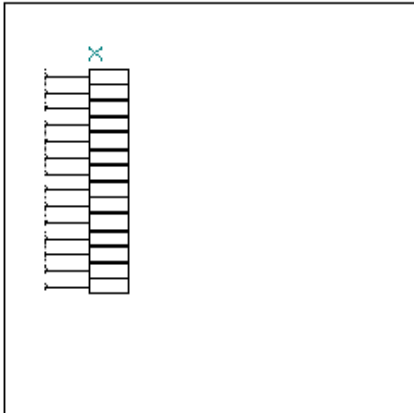

Small_Terminal Block-1Pin

1 elemento

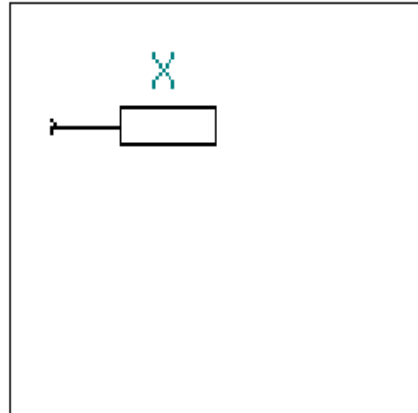

Small_Terminal Block-2Pin

1 elemento

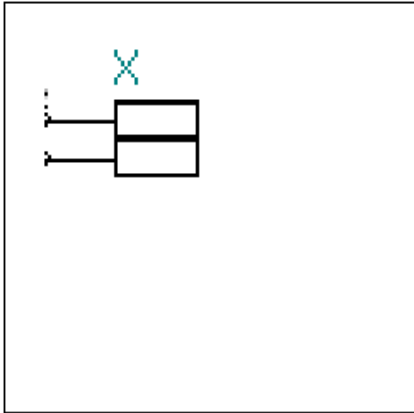

Small_Terminal Block-5Pin

1 elemento

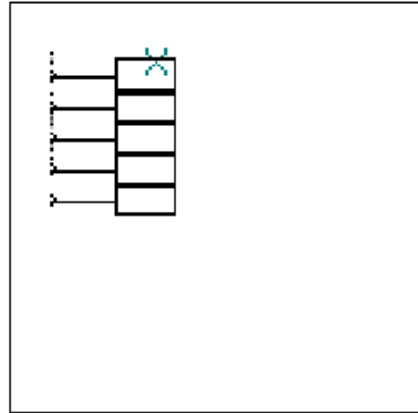

Small_Terminal Block-3Pin

1 elemento

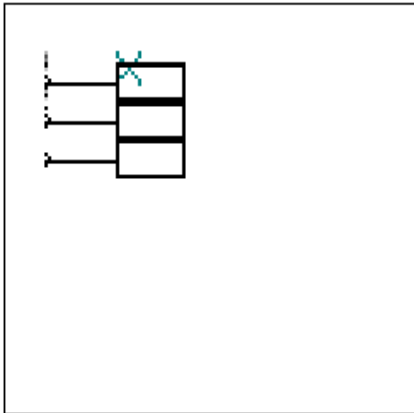

Small_Terminal Block-6Pin

1 elemento

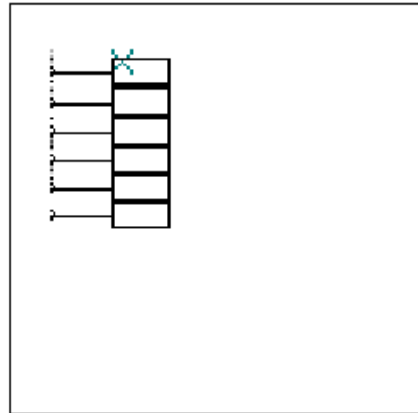

Small_Terminal Block-4Pin

1 elemento

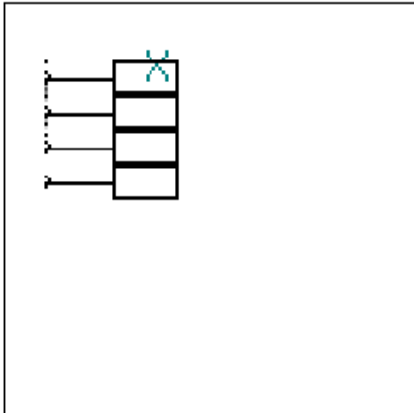

Small_Terminal Block-7Pin

1 elemento

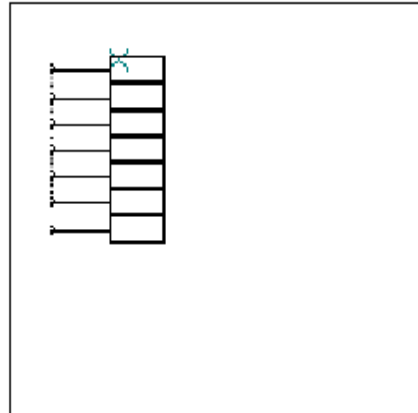

Small_Terminal Block-8Pin

1 elemento

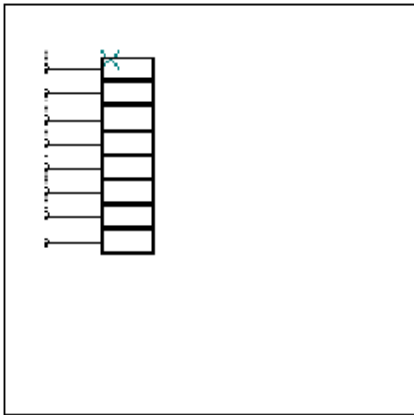

Small_TRANSFORMER

1 elemento

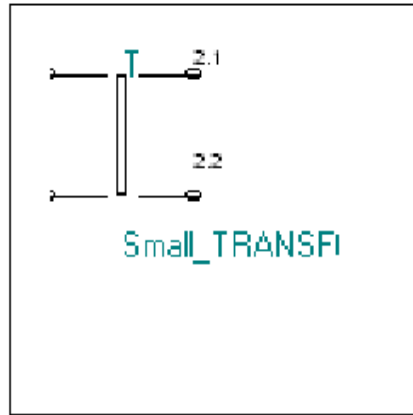

Small_Terminal Block-9Pin

1 elemento

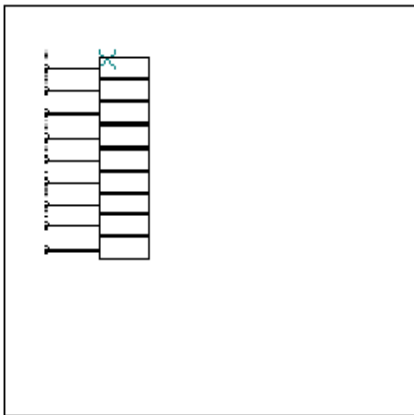

Small_TRANSFORMER-CENTER-TAP-PRIM

1 elemento

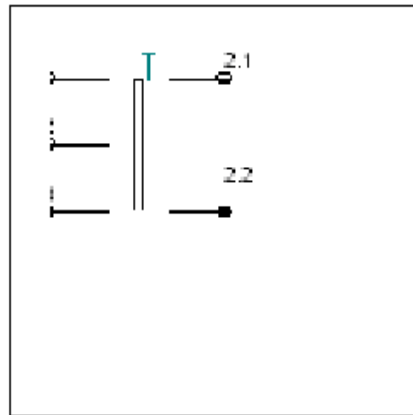

Small_Thyristor-P-Gate

1 elemento

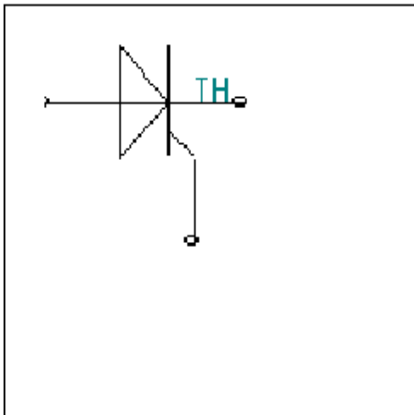

Small_TRANSFORMER-CENTER-TAP-SEC

1 elemento

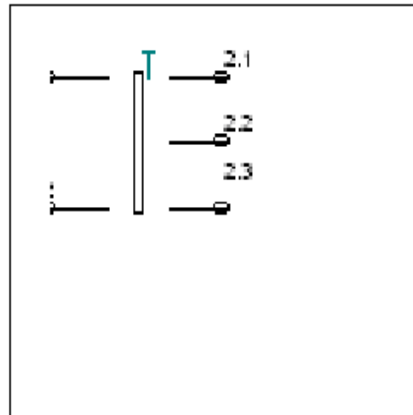

Small_TRANSFORMER-OLD-STYLE

1 elemento

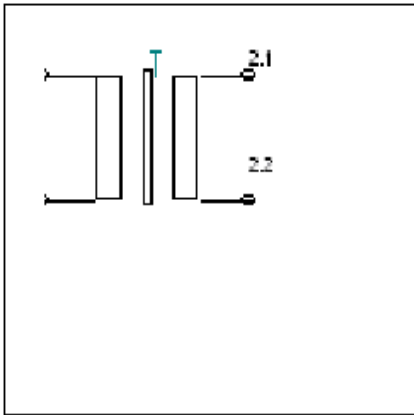

Small_TRANSFORMER-OLD-STYLE I

1 elemento

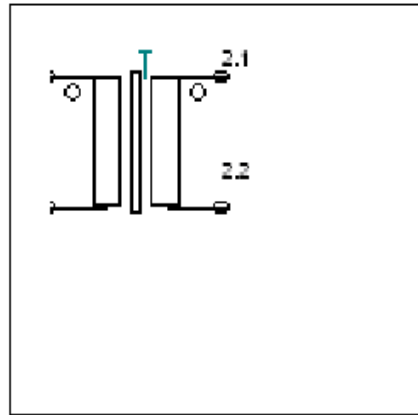

Small_TRANSFORMER-OLD-STYLE-CENTER-TAP-PRIM

1 elemento

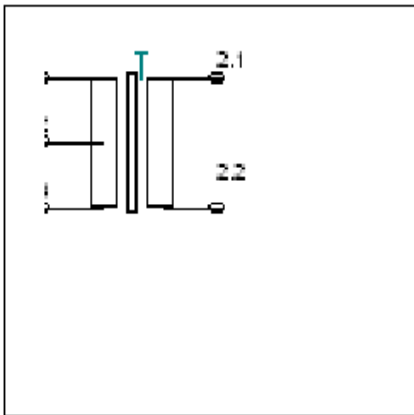

Small_TRANSFORMER-OLD-STYLE II

1 elemento

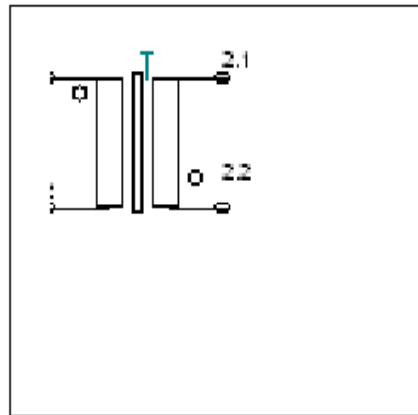

Small_TRANSFORMER-OLD-STYLE-CENTER-TAP-SEC

1 elemento

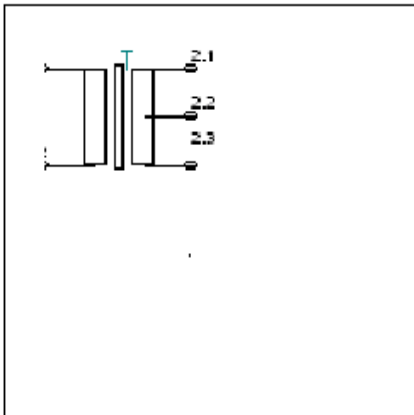

Small_TRANSFORMER I

1 elemento

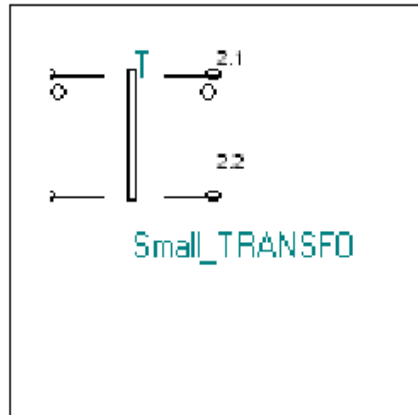

Small_TRANSFORMER II

1 elemento

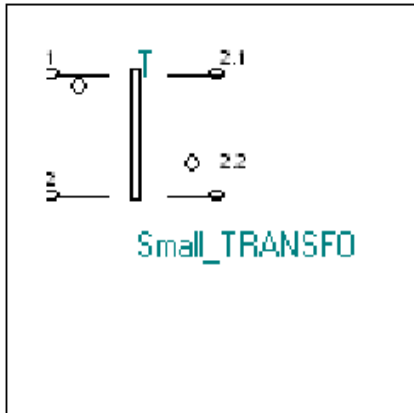

Small_TRANSISTOR-N-JFET

1 elemento

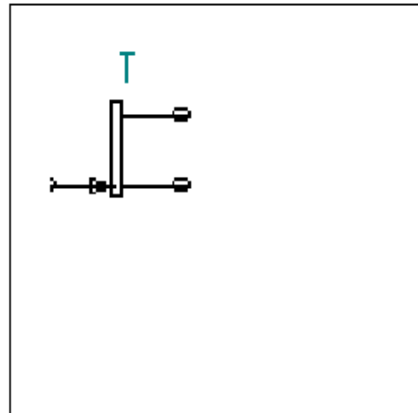

Small_TRANSISTOR-DUAL-GATE-MOSFET

1 elemento

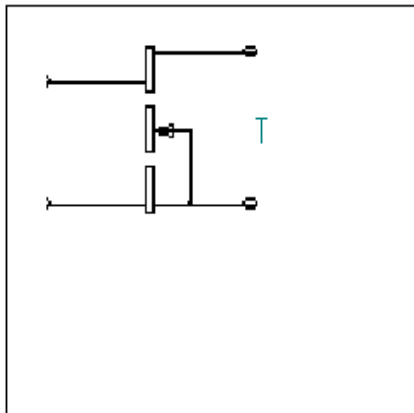

Small_TRANSISTOR-N-MOSFET-DEPLETION

1 elemento

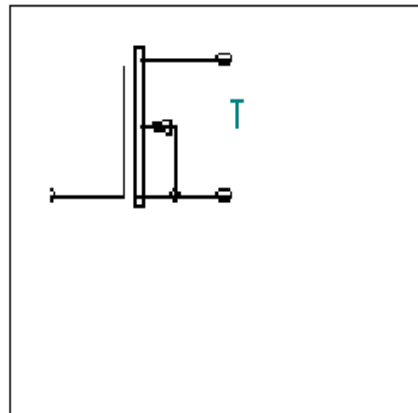

Small_TRANSISTOR-IGBT

1 elemento

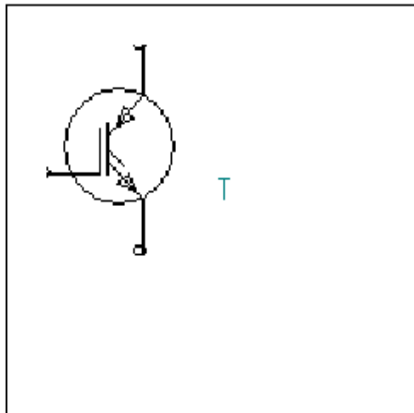

Small_TRANSISTOR-N-MOSFET-FNHANCFMNT

1 elemento

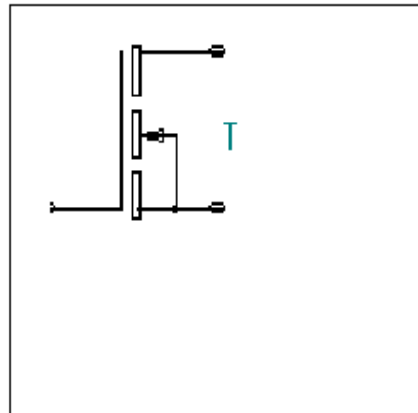

Small_TRANSISTOR-N-UNIJKTION

1 elemento

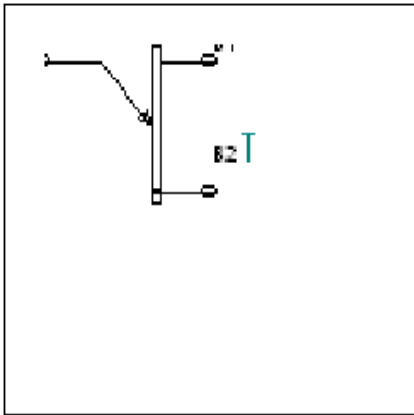

Small_TRANSISTOR-P-JFET

1 elemento

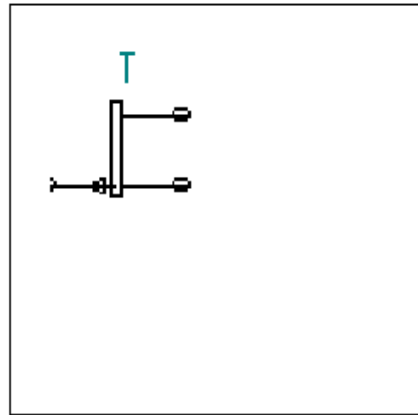

Small_TRANSISTOR-NPN-BIPOLAR

1 elemento

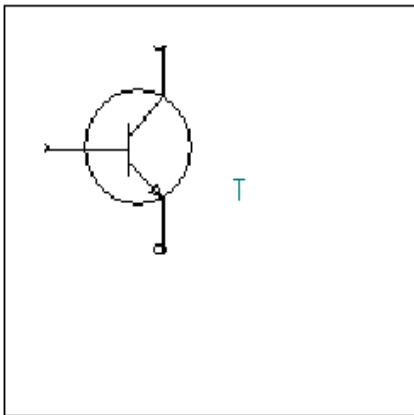

Small_TRANSISTOR-P-MOSFET-DEPLETION

1 elemento

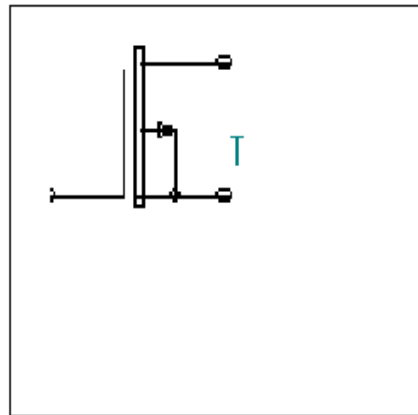

Small_TRANSISTOR-NPN-DARLINGTON-TRANSISTOR

1 elemento

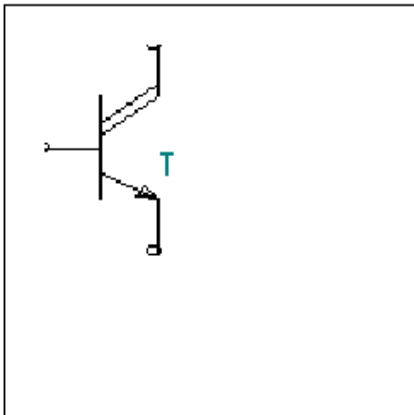

Small_TRANSISTOR-P-MOSFET-FNHANCFMNT

1 elemento

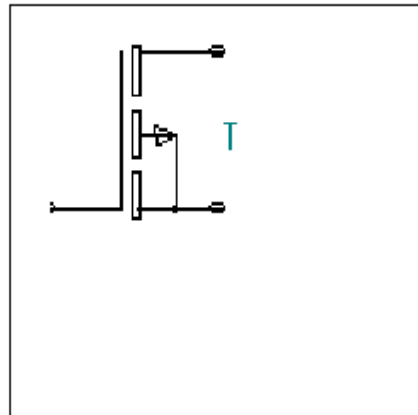

Catálogo de Componentes

4/6/2010 00:34:54

Biblioteca: SymbolsSimilarEN60617+oldDIN617-Rev1Página:136

Small_TRANSISTOR-P-UNIJKTION

1 elemento

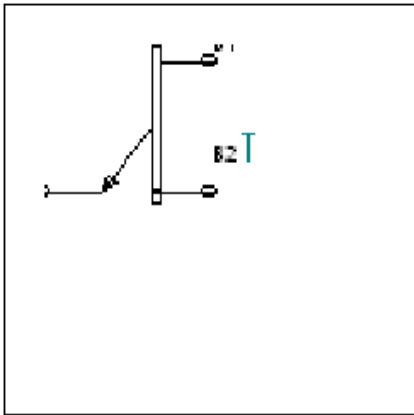

WIRE_CONNECTION I

1 elemento

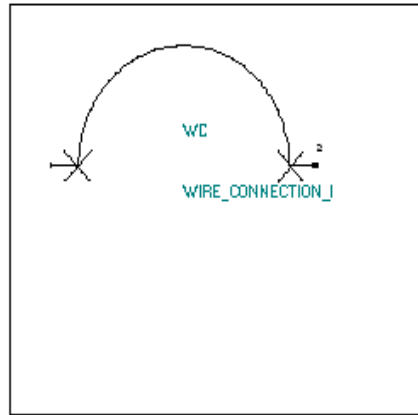

Small_TRANSISTOR-PNP-BIPOLAR

1 elemento

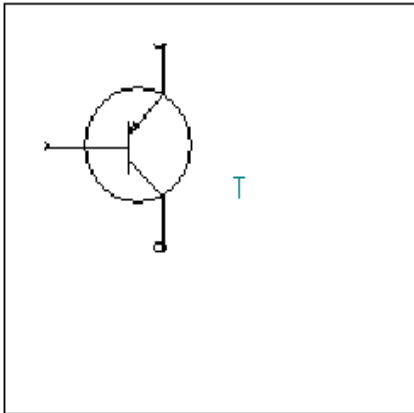

WIRE_CONNECTION II

1 elemento

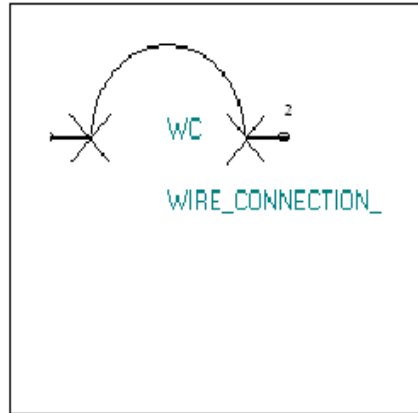

Small_Triac

1 elemento

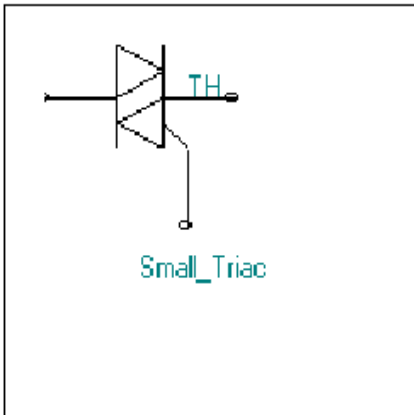

WIRE_CONNECTION III

1 elemento

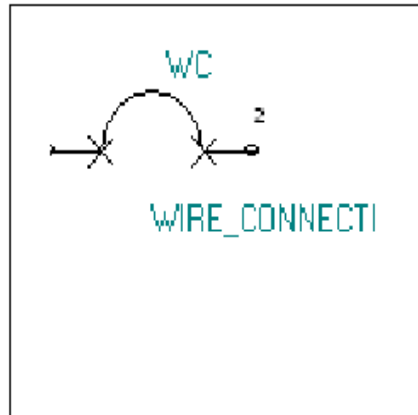

Catálogo de Componentes

4/6/2010 00:34:54

Biblioteca: SymbolsSimilarEN60617+oldDIN617-Rev1Página:137

WIRE_CONNECTION IV

1 elemento

