

<p>BREAKER</p> <p>1 elemento</p> 	<p>CONTACT_NO</p> <p>1 elemento</p> 
<p>CKT_INTERRUPTER</p> <p>1 elemento</p> 	<p>FUSE_OC</p> <p>1 elemento</p> 
<p>CONTACT_NC</p> <p>1 elemento</p> 	<p>LAMP</p> <p>1 elemento</p> 

<p>LAMP_PUSH</p> <p>1 elemento</p> 	<p>LIMIT_SW_HC</p> <p>1 elemento</p> 
<p>LIMIT_PROX_NC</p> <p>1 elemento</p> 	<p>LIMIT_SW_HO</p> <p>1 elemento</p> 
<p>LIMIT_PROX_NO</p> <p>1 elemento</p> 	<p>LIMIT_SW_NC</p> <p>1 elemento</p> 

LIMIT_SW_NO

1 elemento

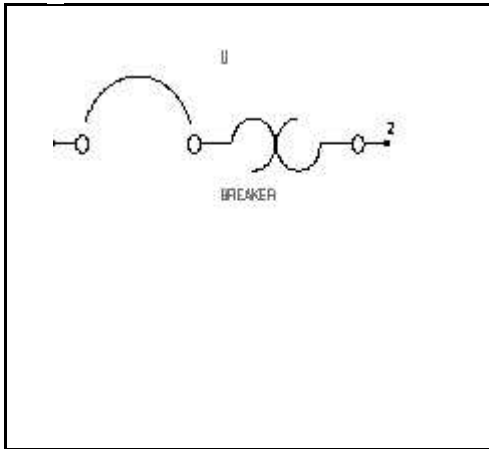
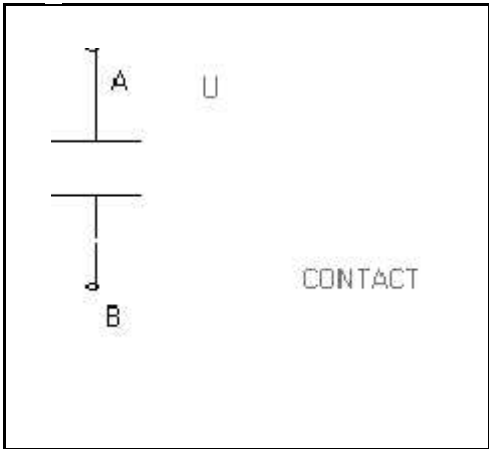
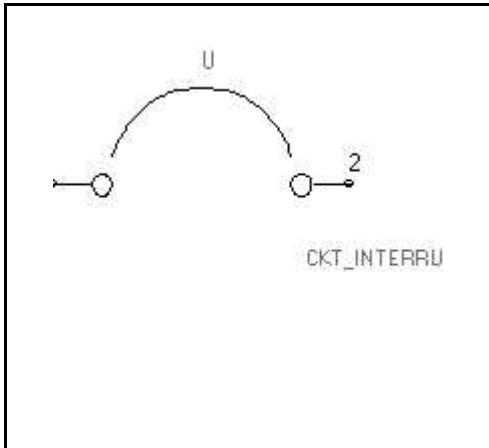
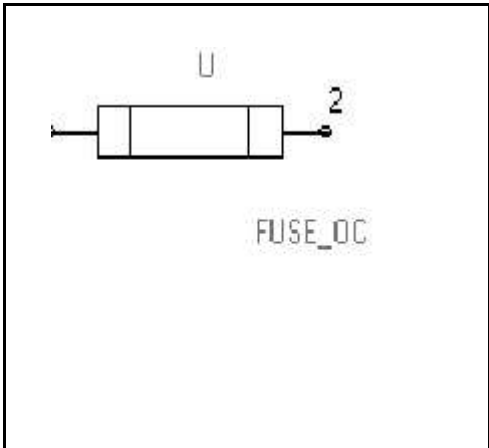
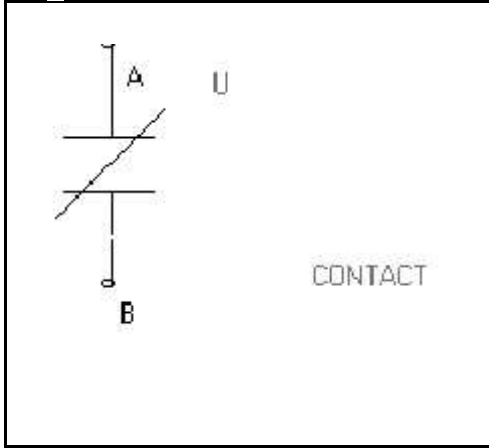
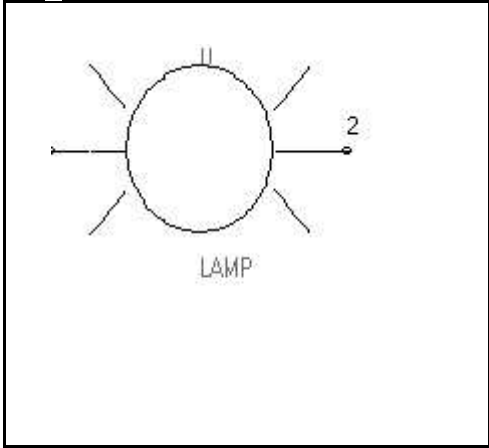
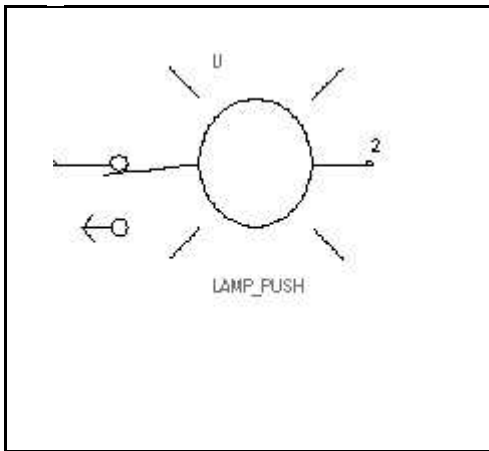
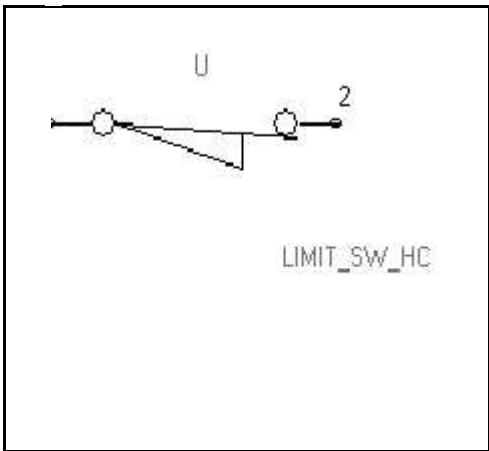
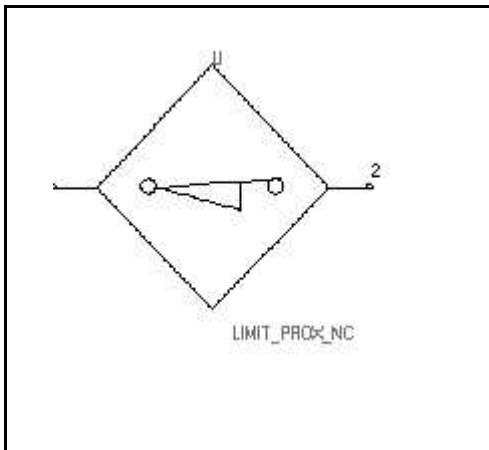
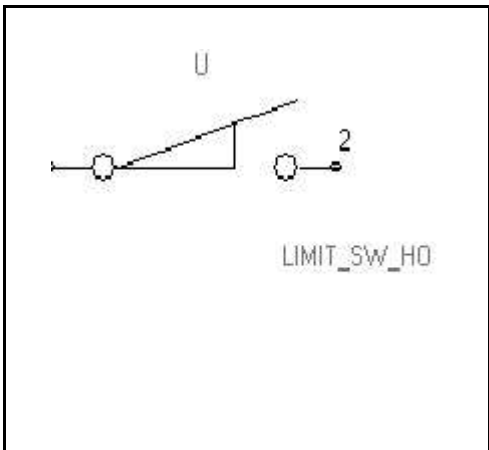
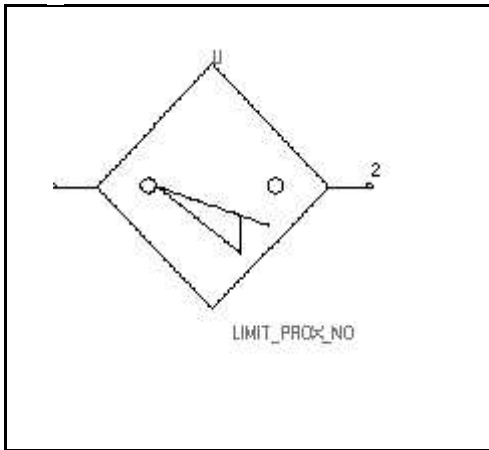
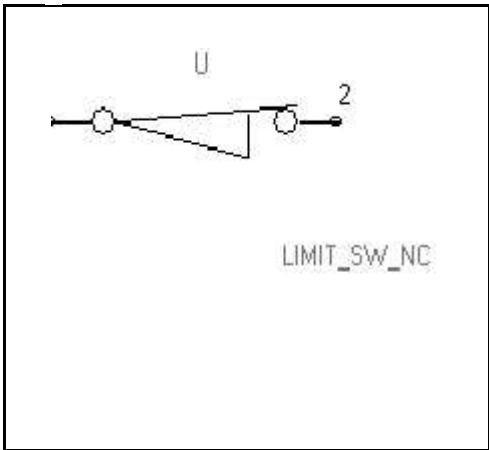
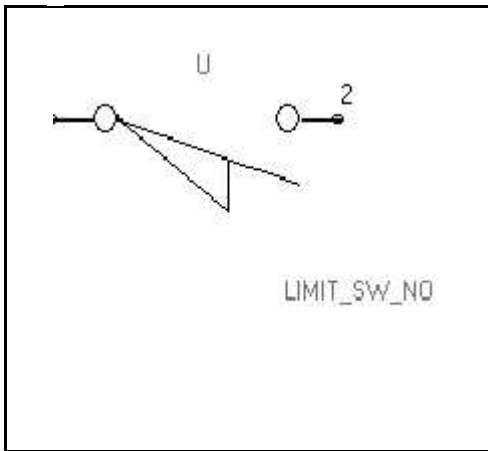

MOTOR_3PHASE

1 elemento

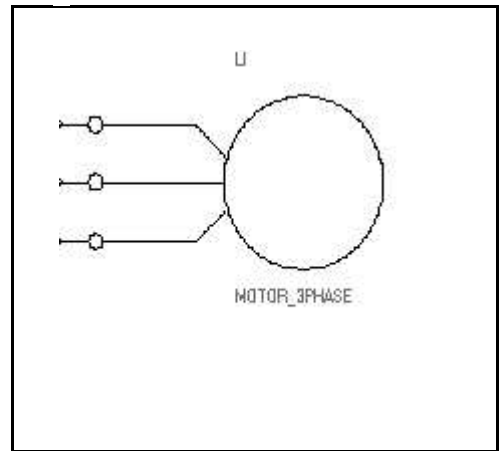

LIQUID_LEVEL_NC

1 elemento

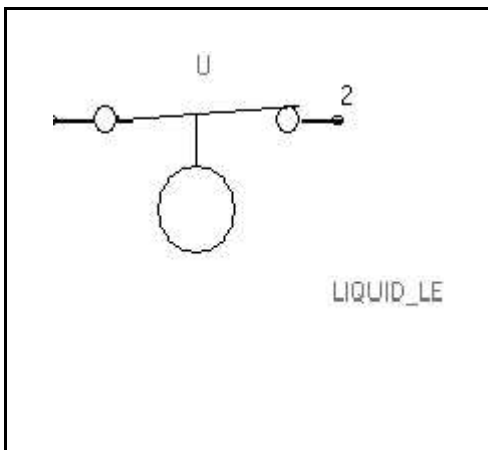

NEON_AC

1 elemento

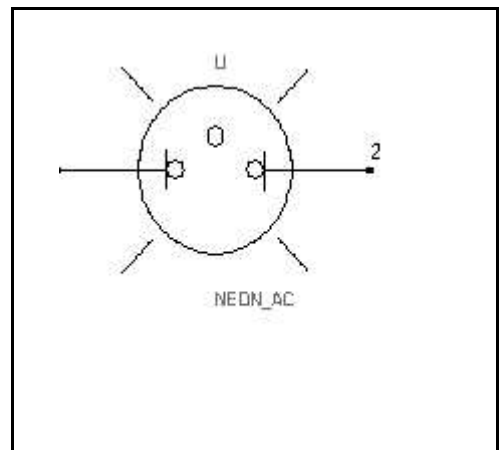

LIQUID_LEVEL_NO

1 elemento

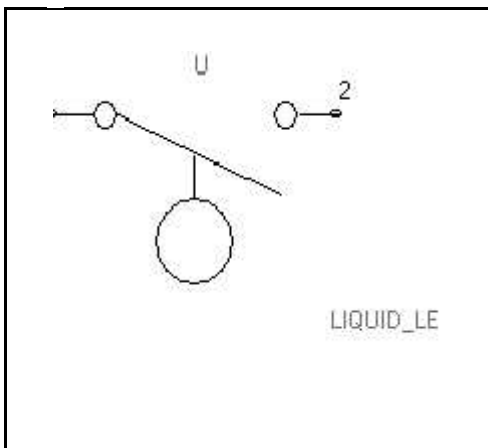

SAFETY_INTERLOC

1 elemento

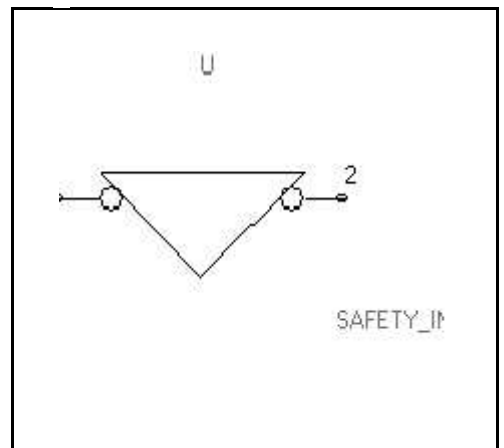

SOLENOID

1 elemento

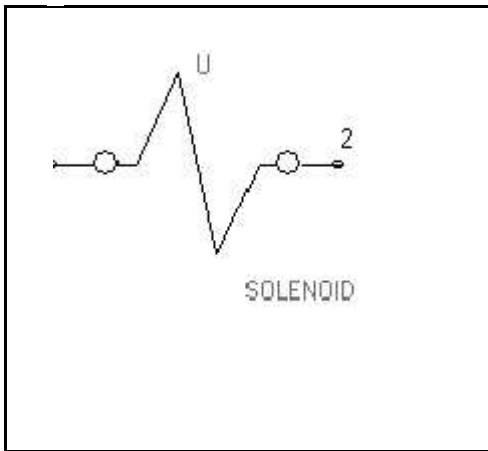

SW_PUSH_DC_MUSH

1 elemento

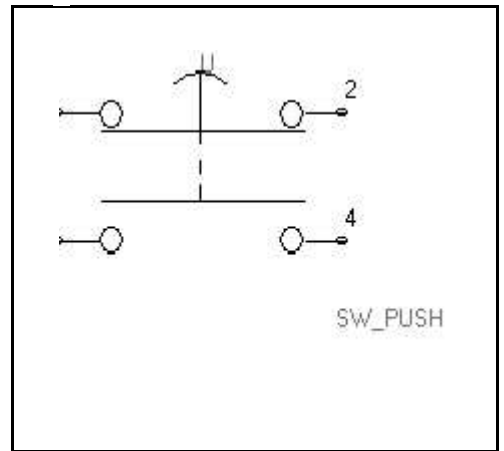

SW_NO

1 elemento

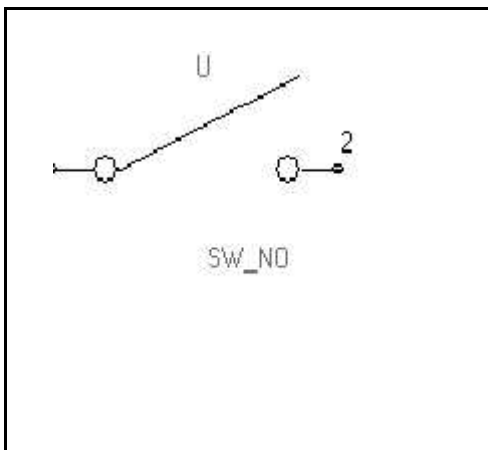

SW_PUSH_SC_NC

1 elemento

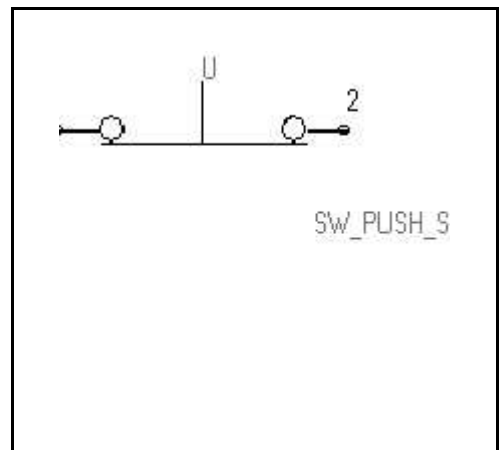

SW_PUSH_DC

1 elemento

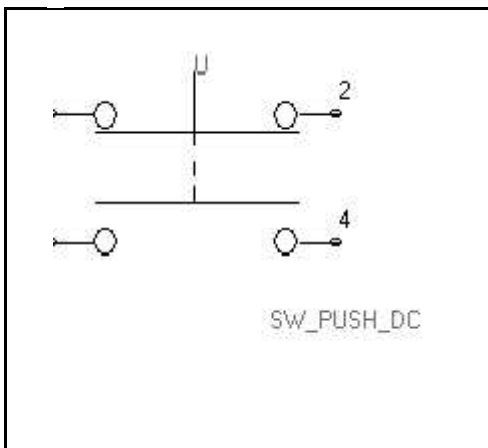

SW_PUSH_SC_NO

1 elemento

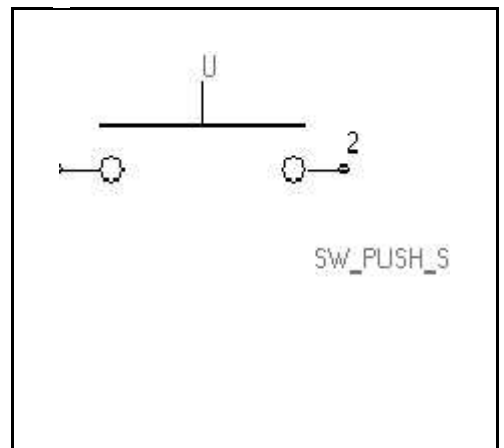

SW_SELECTOR 2-P

1 elemento

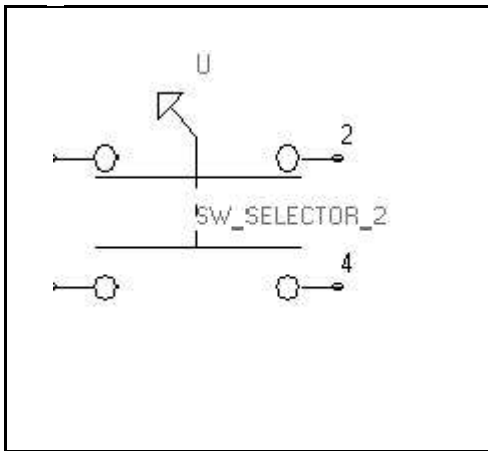

TEMP_NO

1 elemento

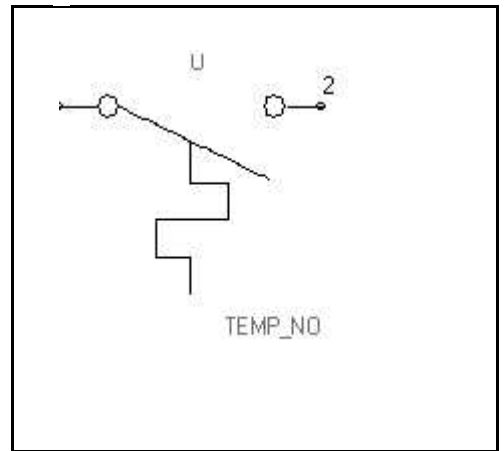

SW_SELECTOR 3-P

1 elemento

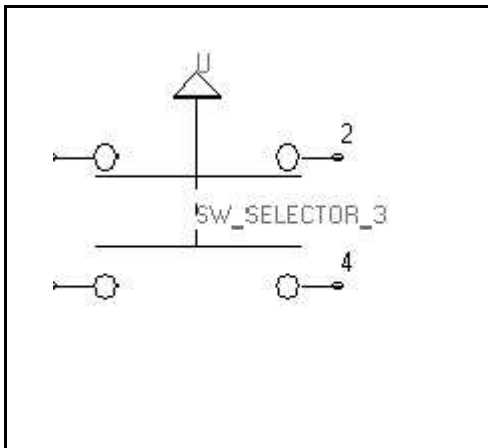

THERMAL_OVERLOA

1 elemento

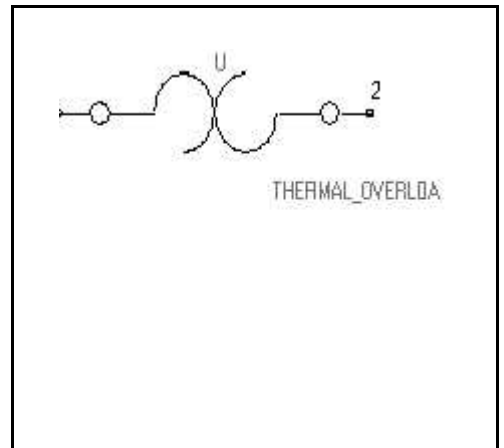

TEMP_NC

1 elemento

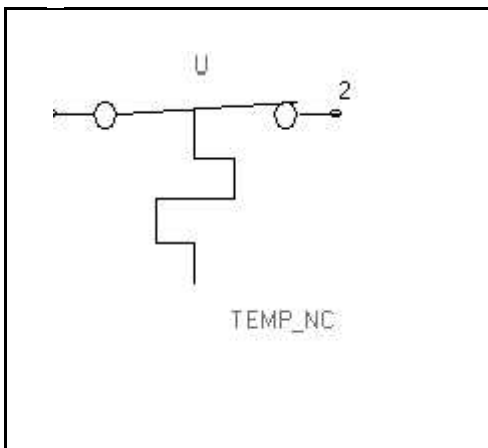

TRANSFORMER

1 elemento

