

80186

1 elemento

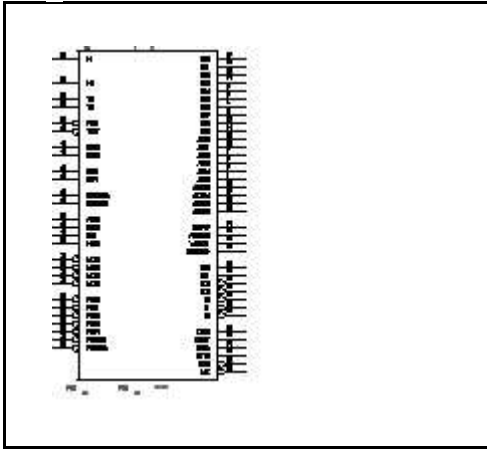

80287

1 elemento

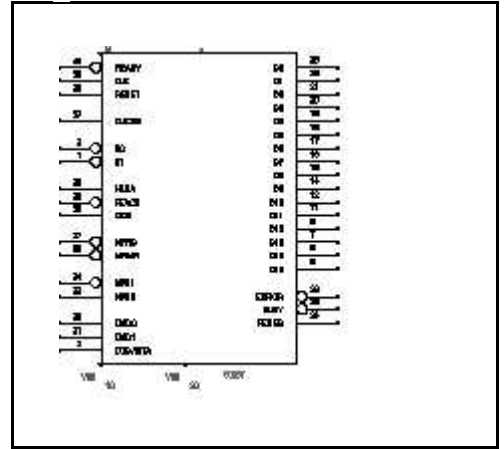

80188

1 elemento

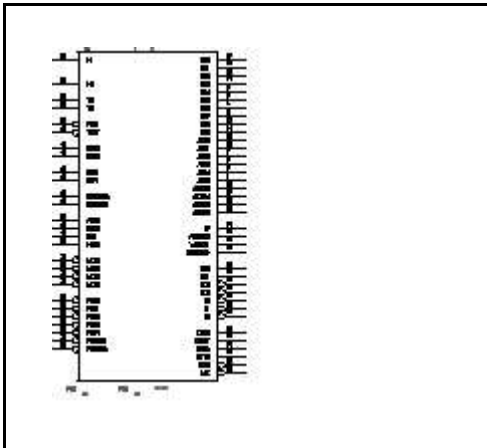

8031

ALIAS 80C31
8051 80C51
8751

1 elemento

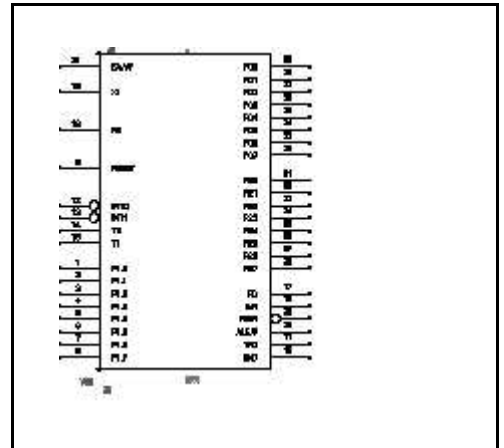

80286

1 elemento

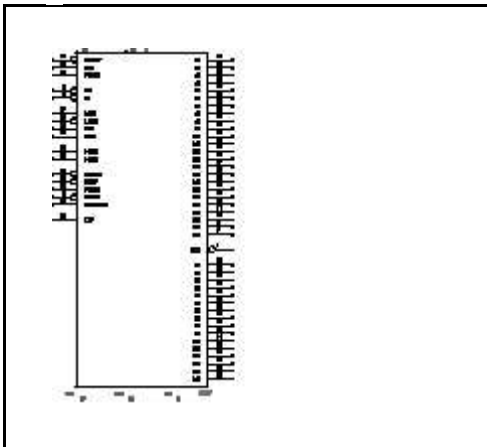

8032

ALIAS 8052

1 elemento

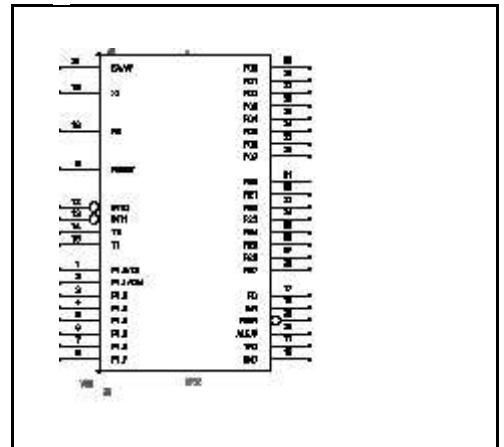

8035

ALIAS 80C35
8039 80C39
8040 8048
80C48 8049
80C49 8050
8748 8749

1 elemento

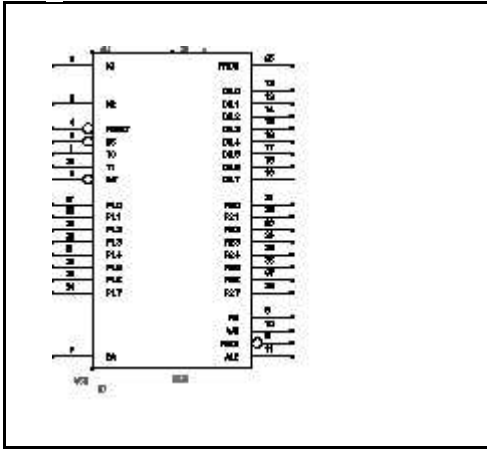

8044

ALIAS 8344
8744

1 elemento

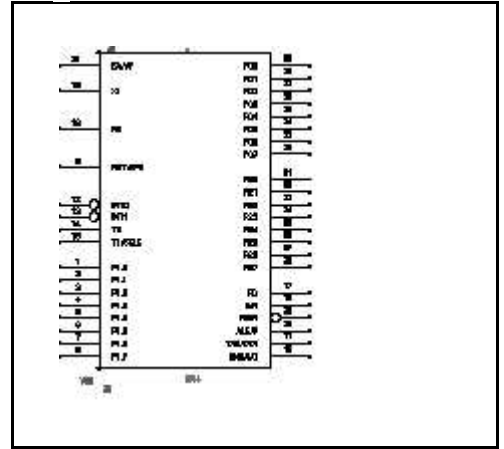

80386

1 elemento

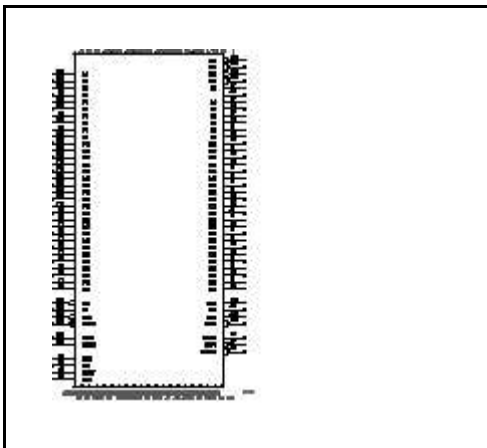

8085

1 elemento

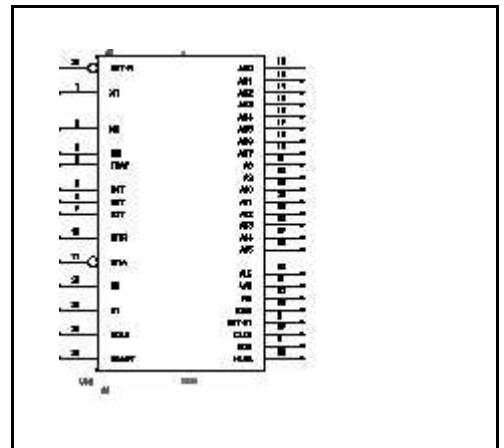

8041

ALIAS 8042
8641 8741
8742

1 elemento

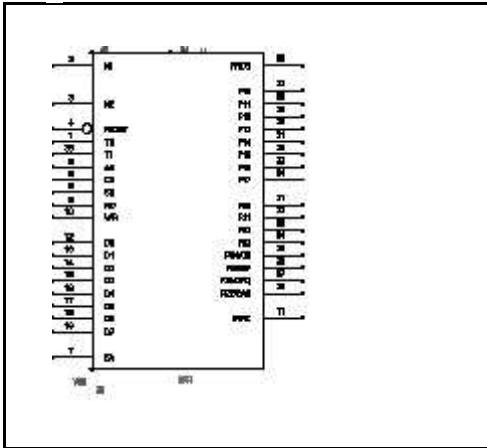

8086MAX

1 elemento

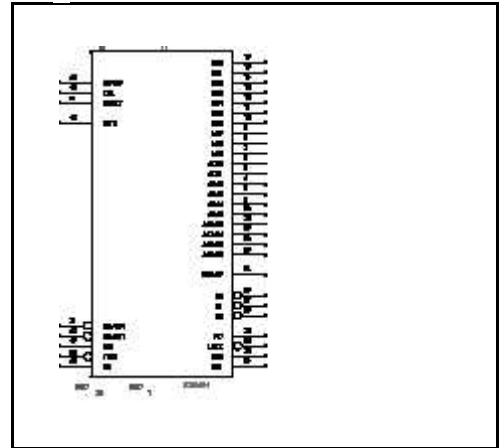

8086MIN

1 elemento

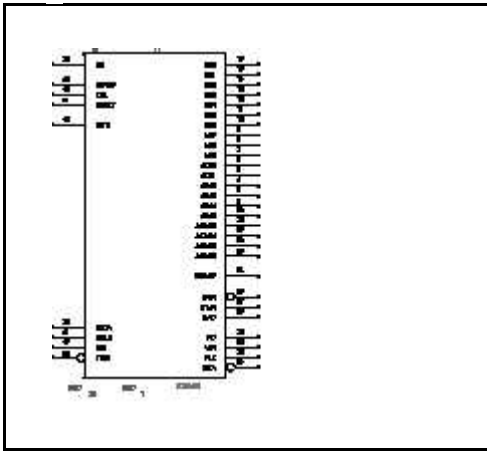

8088MAX

1 elemento

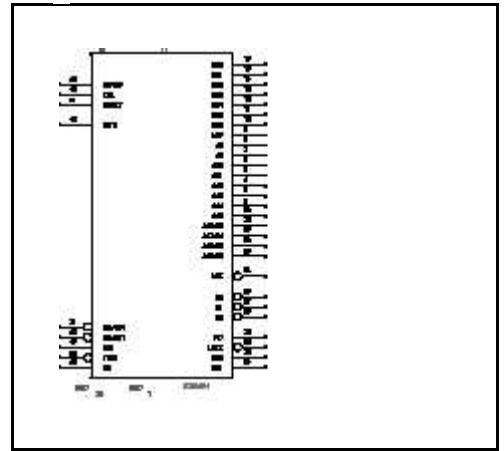

8087

1 elemento

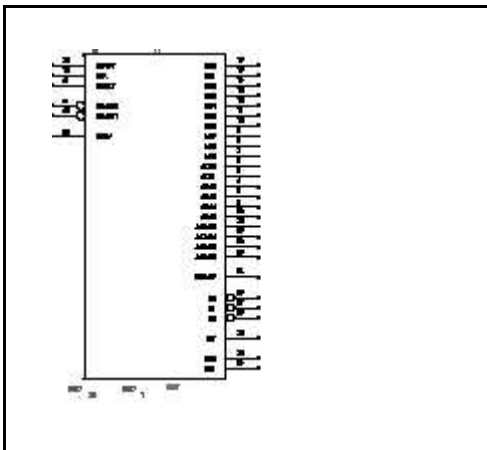

8088MIN

1 elemento

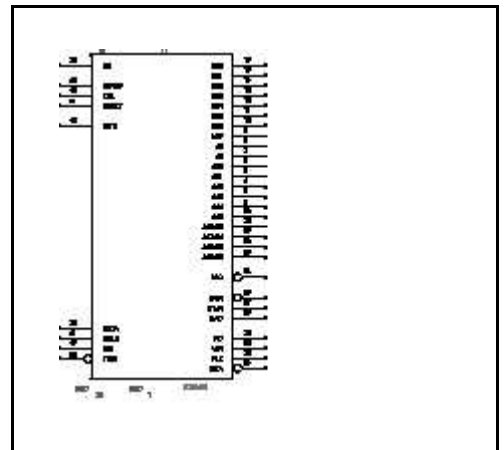

8088

1 elemento

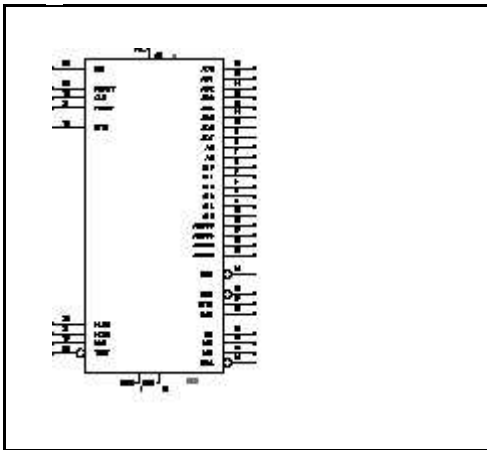

8089

1 elemento

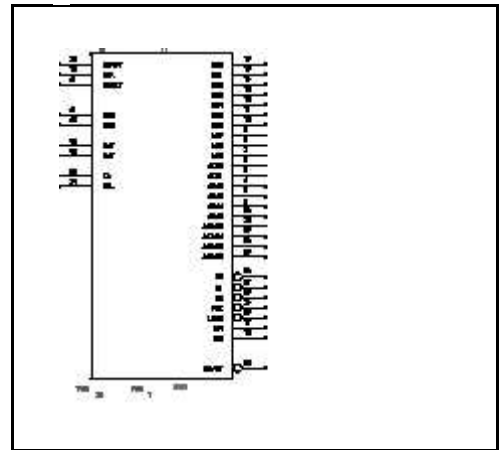

8096

ALIAS 8396

1 elemento

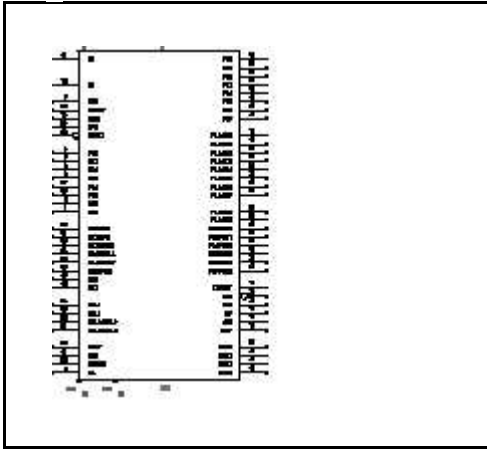

8156

1 elemento

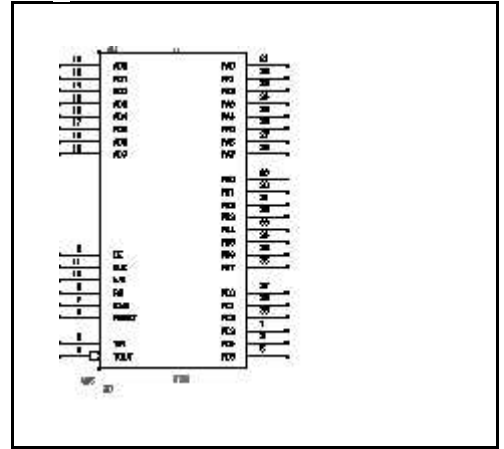

8097

ALIAS 8397

1 elemento

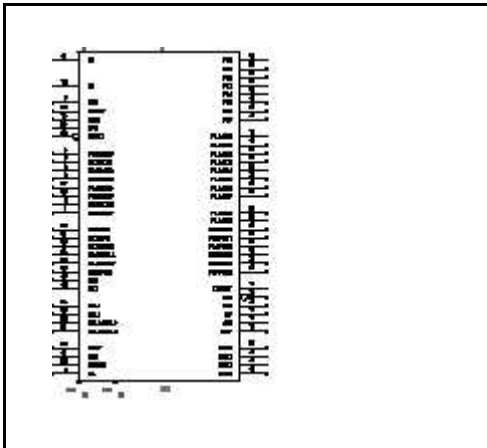

8185

1 elemento

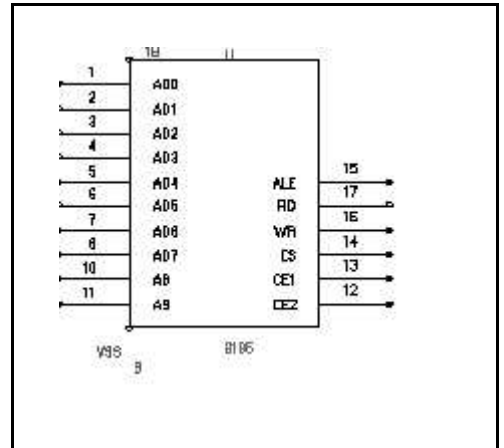

8155

1 elemento

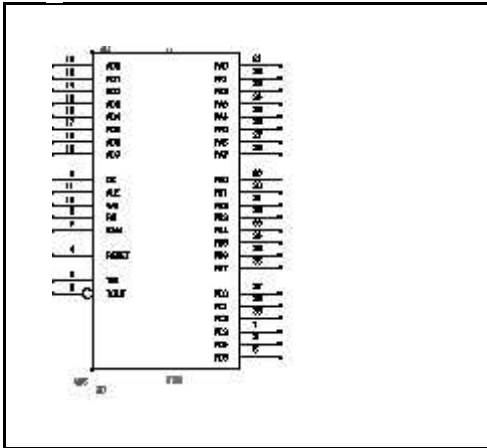

8203

1 elemento

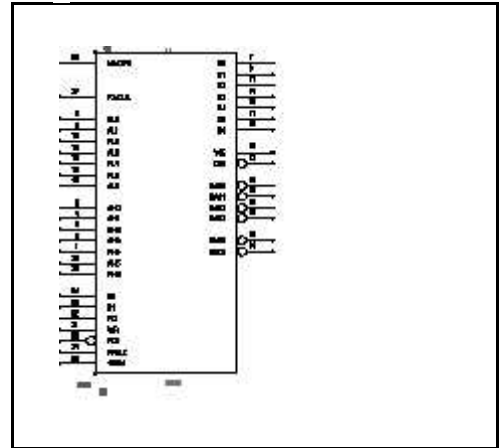

8205

1 elemento

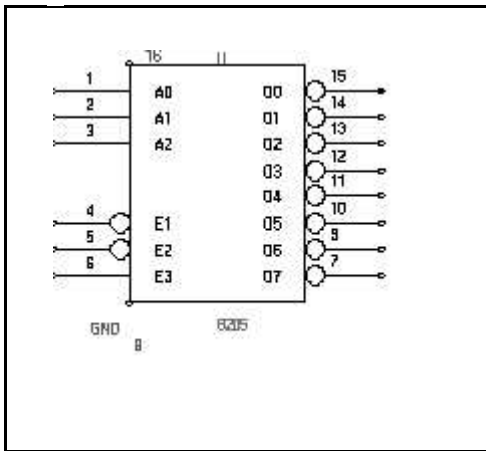

8206-2

1 elemento

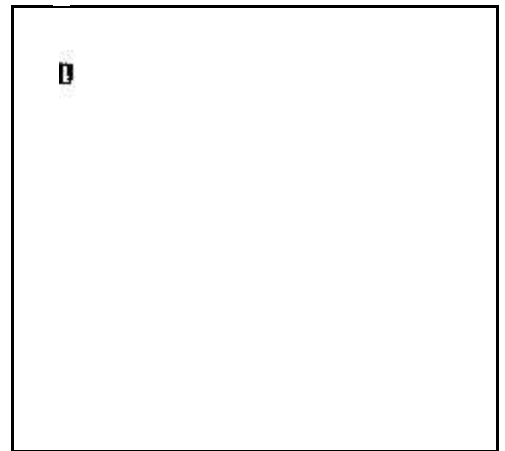

82050

1 elemento

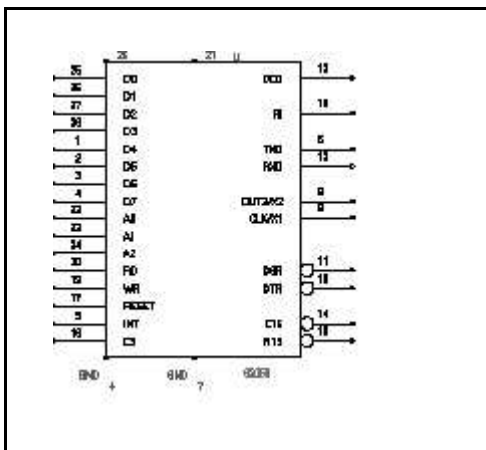

82062

1 elemento

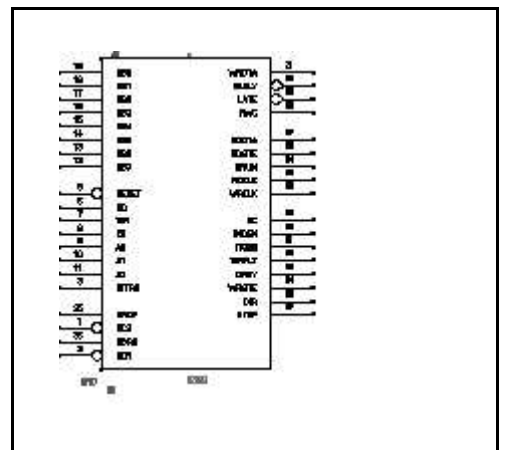

8206

1 elemento

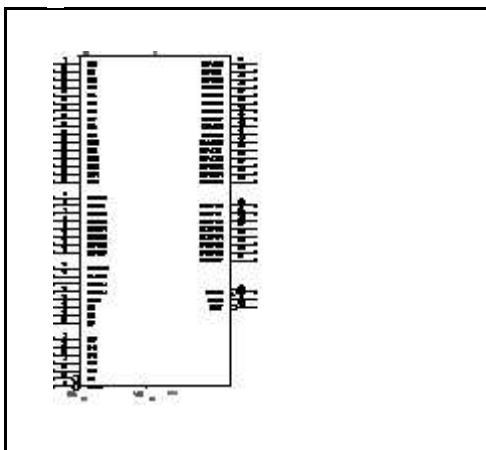

82064

1 elemento

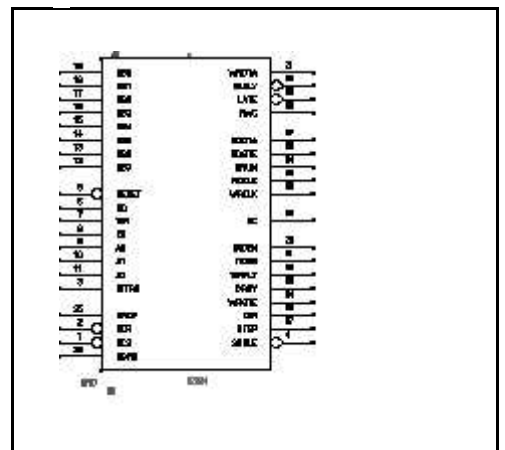

8207

1 elemento

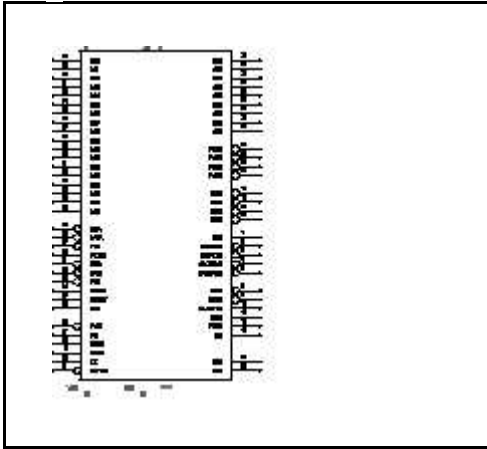

8216

1 elemento

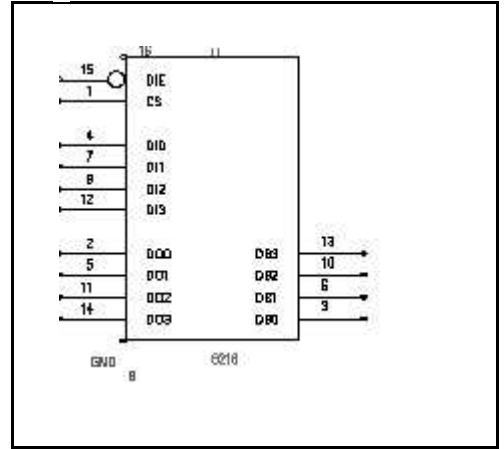

8208

1 elemento

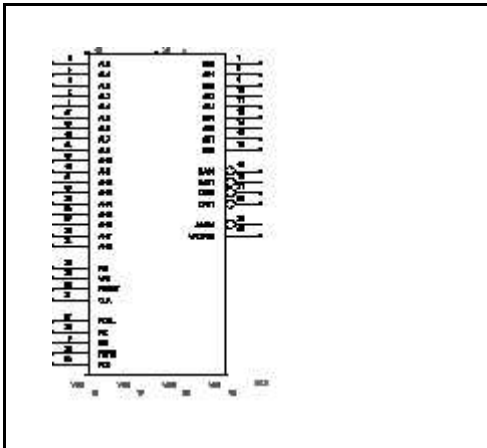

82188

1 elemento

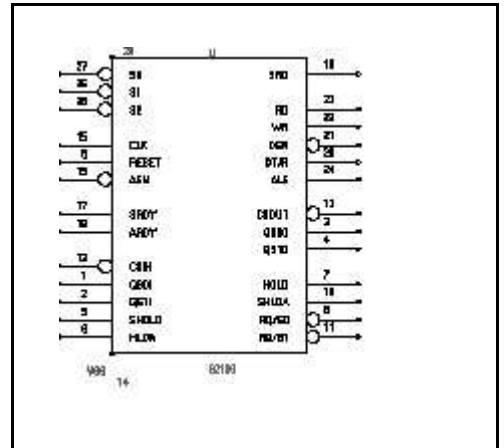

8212

1 elemento

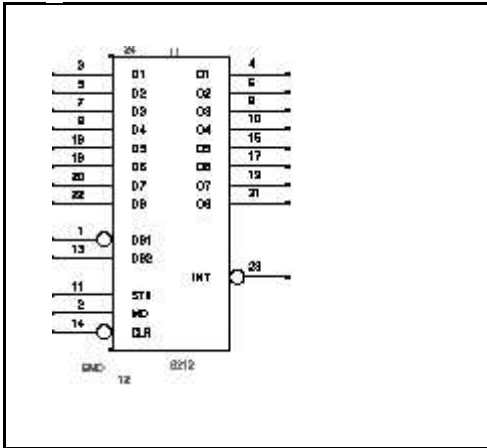

8226

1 elemento

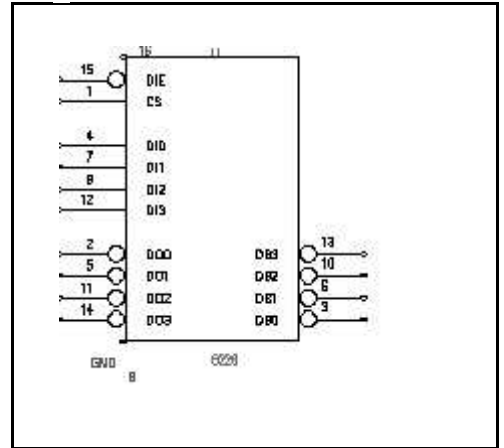

8243

1 elemento

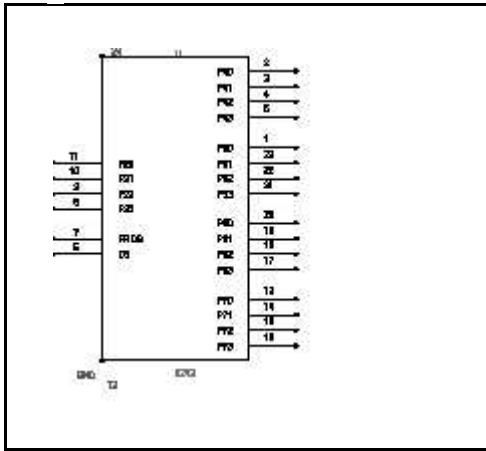

8253

ALIAS 8254
82C54
UPD71054

1 elemento

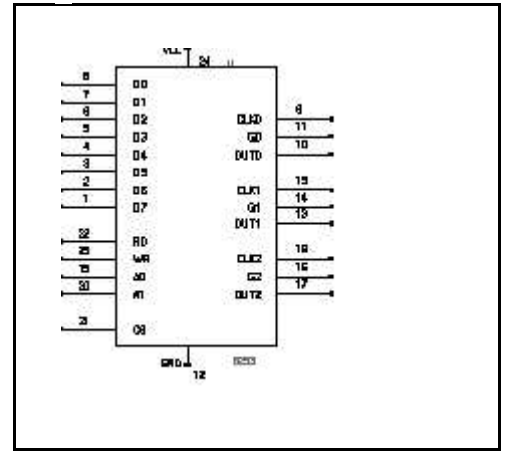

82501

1 elemento

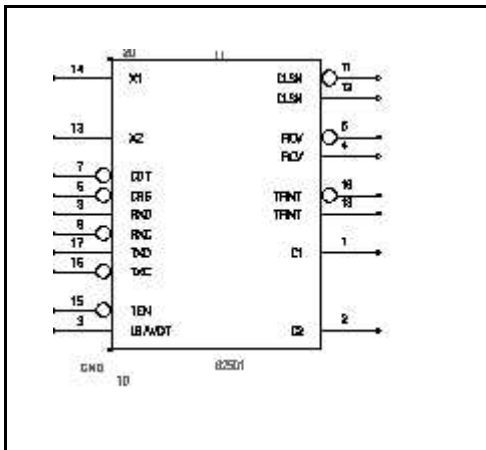

82530

1 elemento

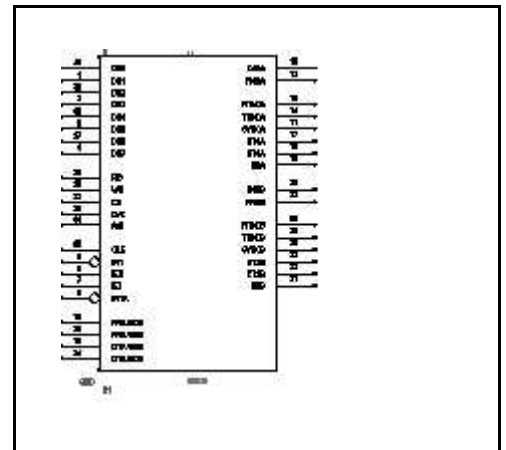

8251

ALIAS 8251A
UPD71051

1 elemento

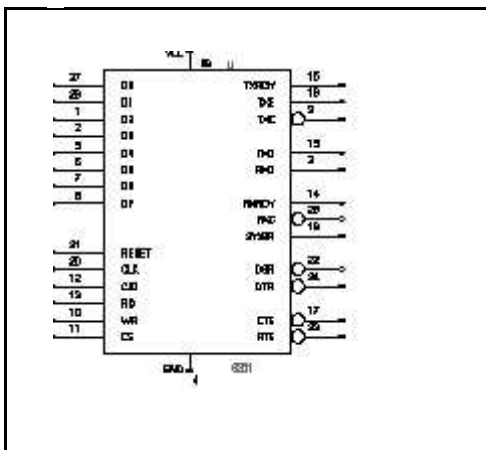

8255

ALIAS 82C55

1 elemento

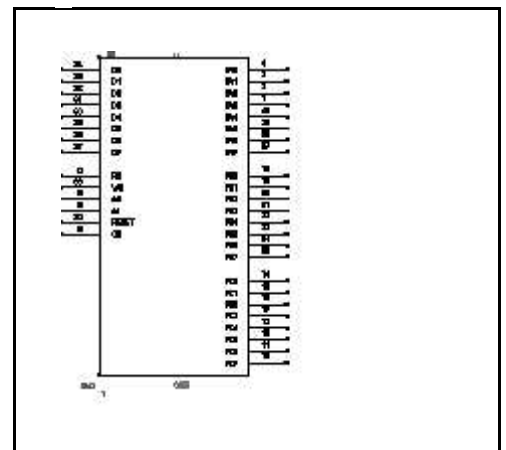

8256

1 elemento

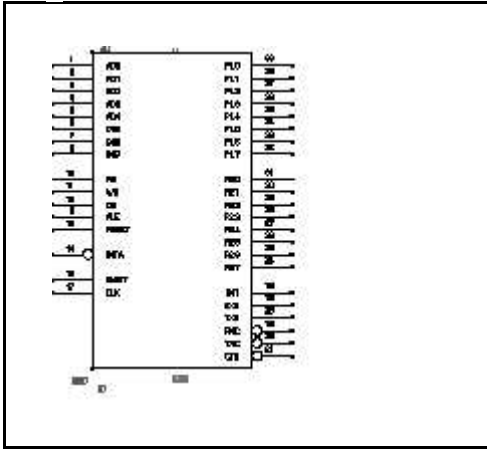

82586MIN

1 elemento

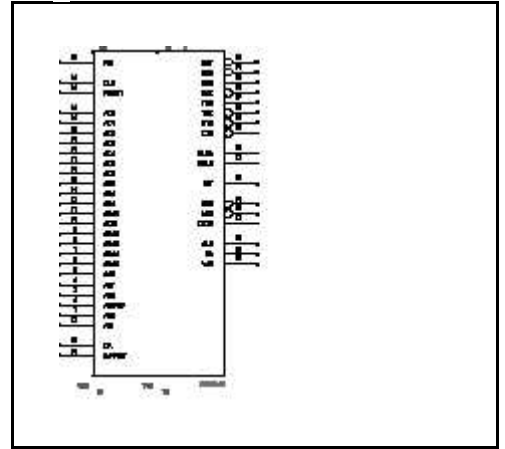

8257

1 elemento

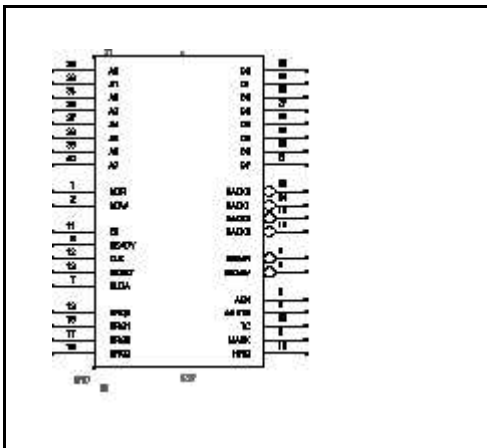

82588HIM

1 elemento

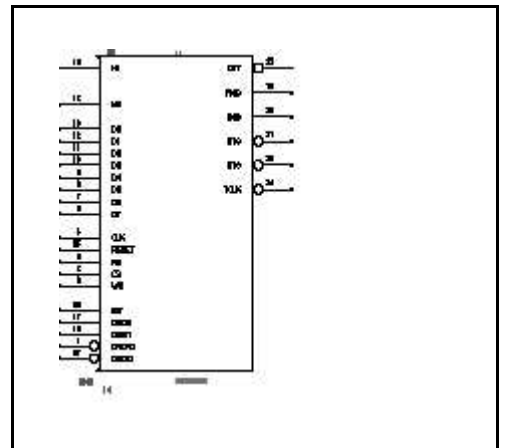

82586MAX

1 elemento

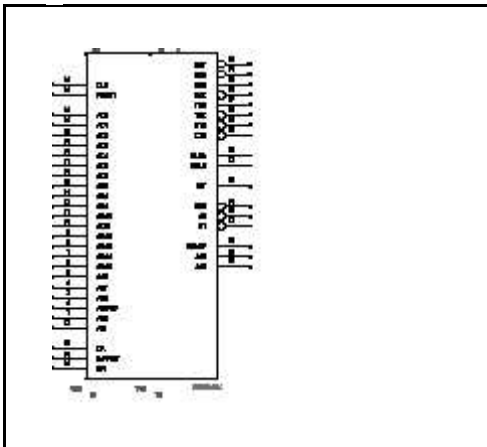

82588HSM

1 elemento

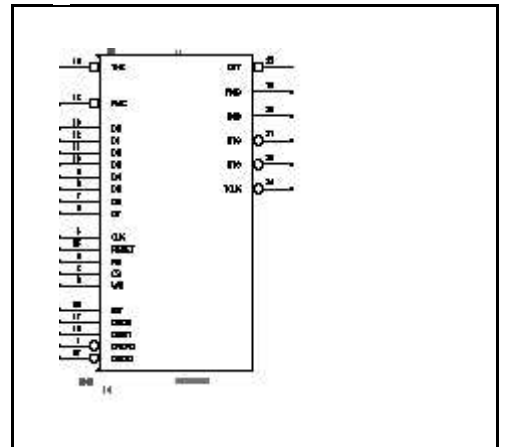

8259

ALIAS 8259A

1 elemento

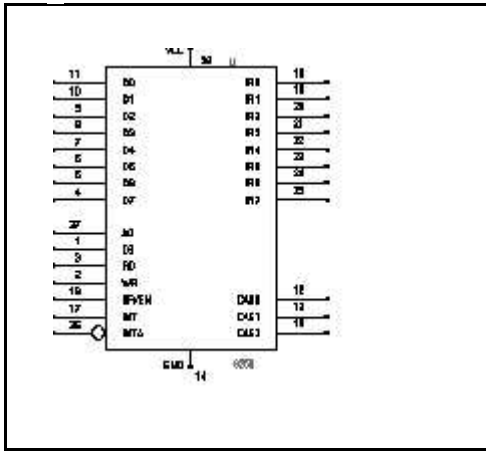

8273

1 elemento

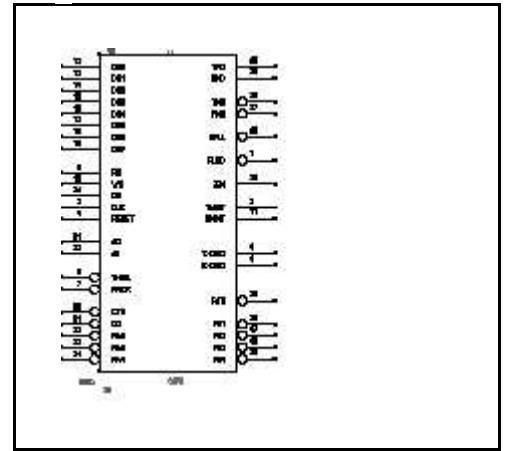

8272

ALIAS 8272A

1 elemento

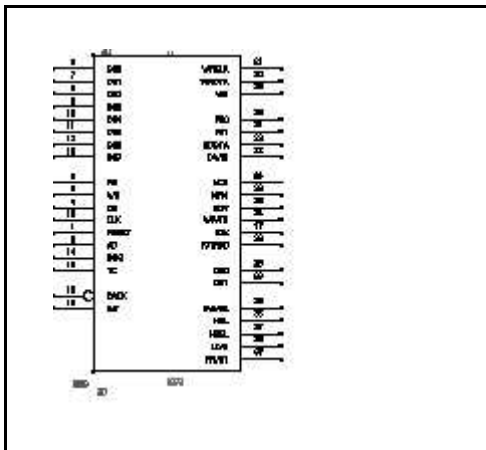

82731

1 elemento

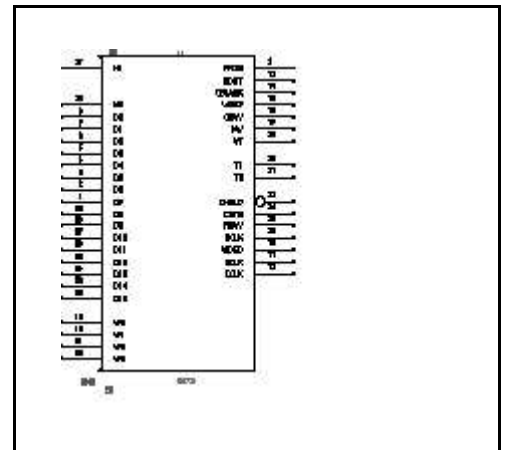

82720

1 elemento

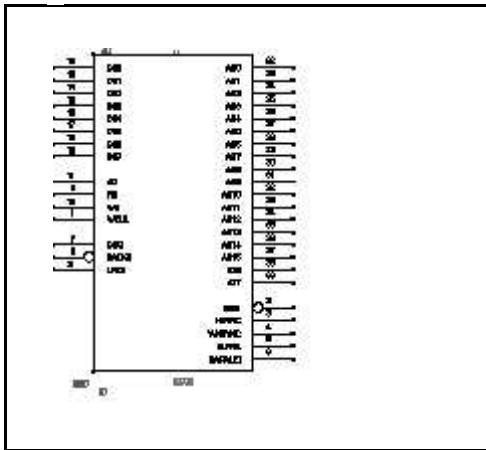

8274

1 elemento

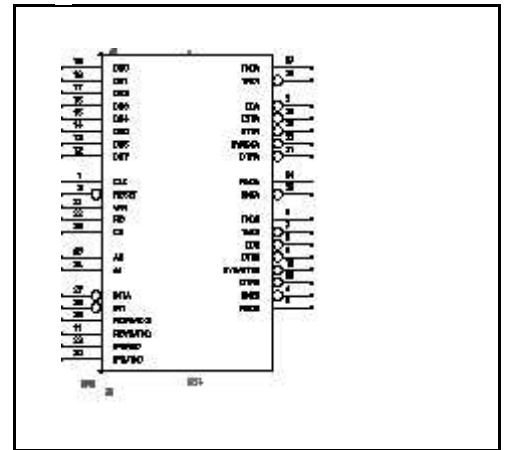

8275

1 elemento

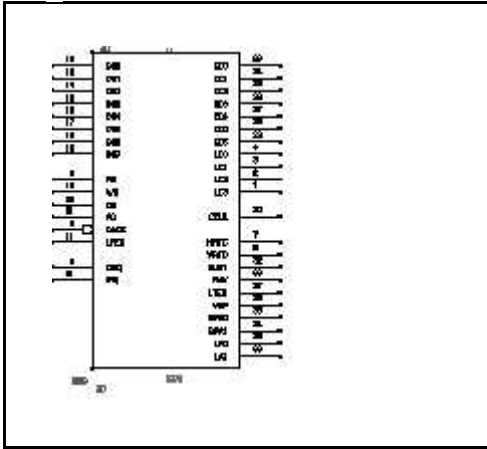

8282

1 elemento

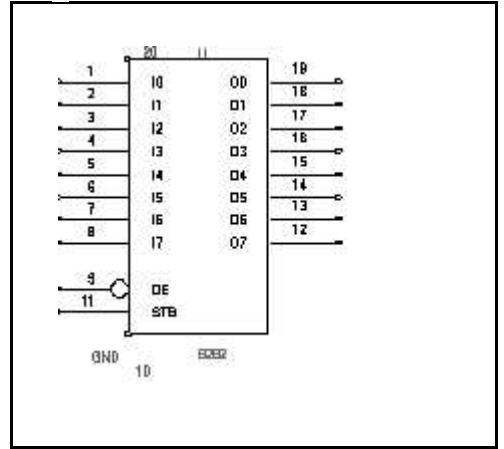

8276

1 elemento

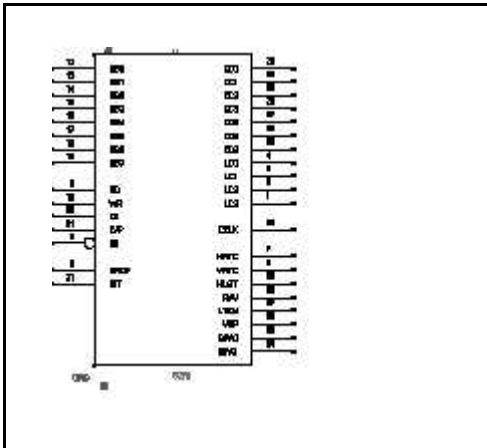

8283

1 elemento

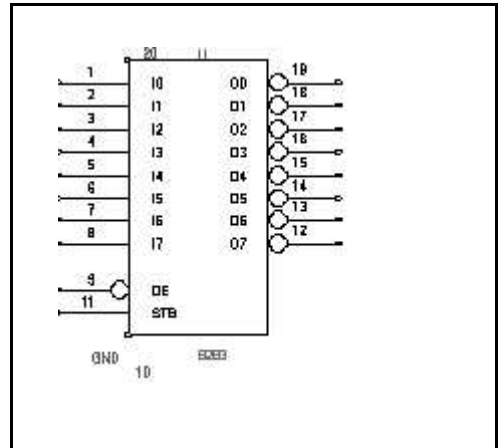

8279

1 elemento

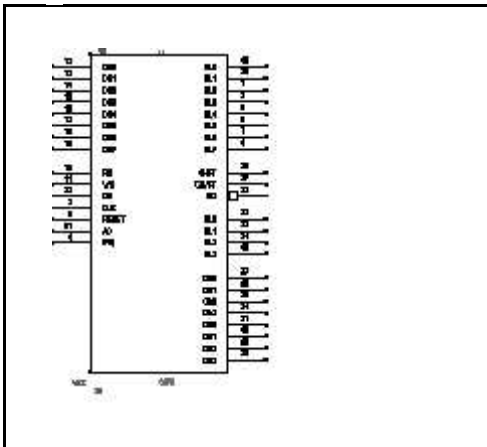

8284

1 elemento

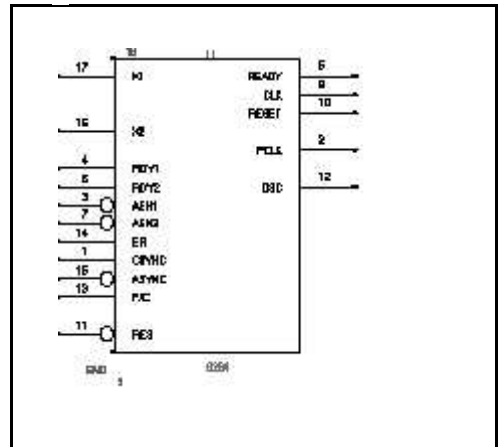

8286

ALIAS 8287

1 elemento

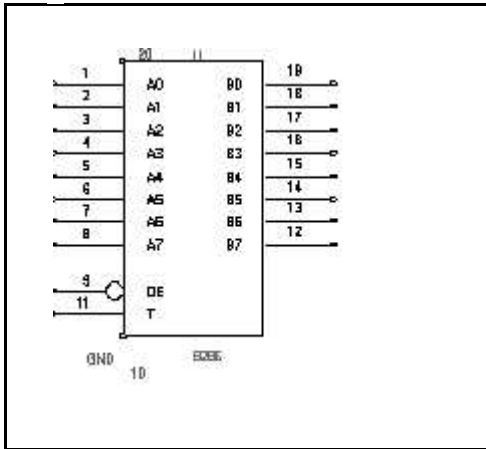

8291

1 elemento

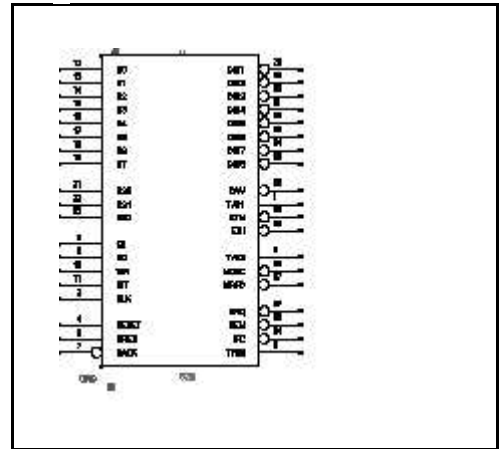

8288

1 elemento

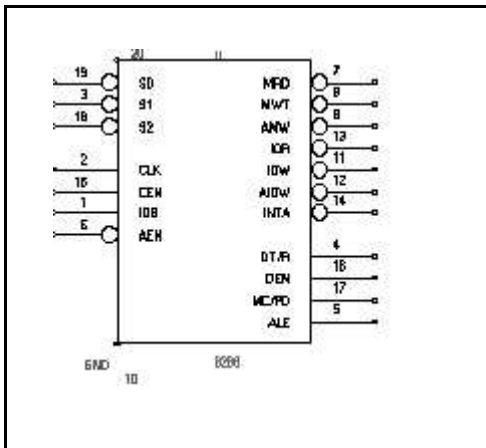

8292

1 elemento

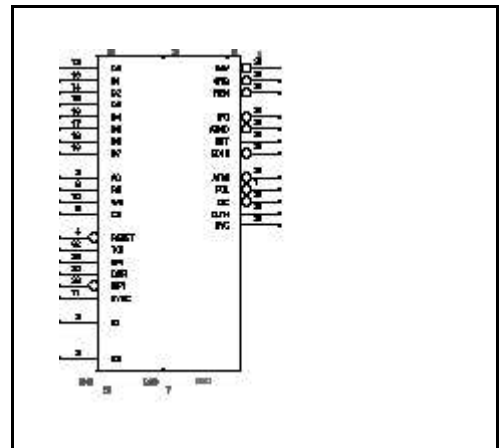

8289

1 elemento

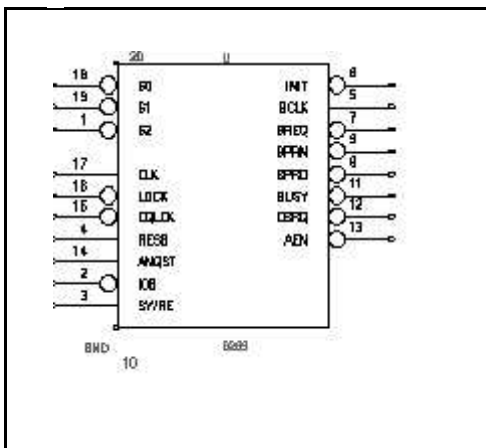

8294

ALIAS 8294A

1 elemento

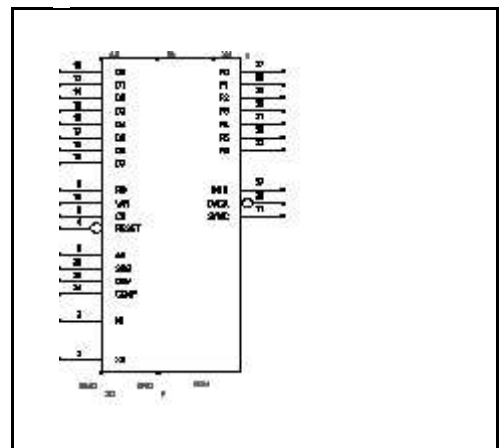

8295

1 elemento

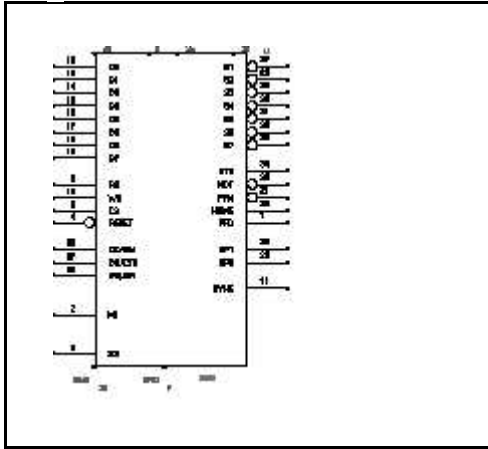

P89027

1 elemento

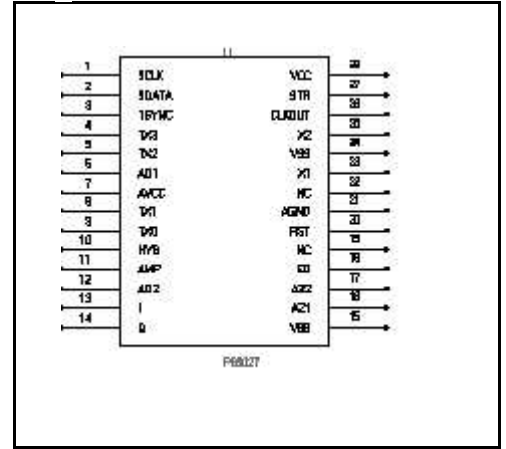

8755

1 elemento

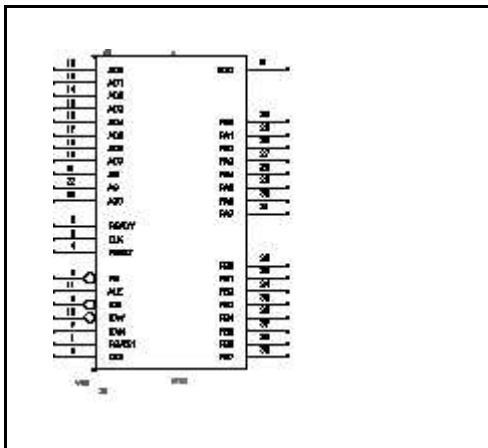

N89026

1 elemento

